



DEMAND QUALITY...



DEMAND U.S. SEAL

A COMPLETE LINE OF QUALITY SEALS

ADVANTAGES OF U.S. SEALS

As most engineers know, a successful seal must be designed to give long life, reduce maintenance and provide automatic self adjustment. The seals in the U.S. Seal line meet these basic requirements. In addition, they offer other important advantages to the seal user.



1. **ABSOLUTE SEALING** - resulting in less pumpage losses, cleaner environmental facilities, less fire hazard, no danger from fumes and no contamination of the fluid being handled.

2. **NO RUBBING FRICTION BETWEEN SHAFT AND SEAL PARTS.**

By replacing your old packing with new state-of-the-art U.S. Seal mechanical seals, there is no more expensive shaft or sleeve replacements.



3. **MORE FLEXIBILITY WITH SEALS MEANS LONGER SERVICE LIFE.**

Seals have more flexibility than packing and are able to compensate for shaft deflection, axial and radial end play, as well as vibration and wear of the sealing faces.



4. **LESS FRICTION MEANS VALUABLE POWER SAVINGS.**

Seals use less friction than packing and therefore, require less horsepower consumption.

5. **PRECISION LAPPED SEALING SURFACES.**

Positively control leakage and eliminate "break in" runs.

6. **HIGHER SPEEDS AND PRESSURES ARE NO PROBLEMS.**

7. **EXTREME FLAT SURFACES OF MATING FACES.** Care is taken to furnish precision lapped sealing surfaces with a flatness within three light bands which maintains the necessary face film lubrication.



8. **MATERIALS OF CONSTRUCTION.** Teflon, AFLAS[®], Viton[®], EPR and PTFE materials are available for those applications where Neoprene and Buna are not compatible with the process fluid. Metal parts are normally made of brass, plated steel or stainless steel, but other alloys, such as Monel and Hastelloy can be supplied. Seal materials are available in a wide selection.



TYPICAL U.S. SEAL MFG. SEAL INSTALLATION

- SWIMMING POOL PUMPS
- CENTRIFUGAL PUMPS
- ROTARY PUMPS
- JET PUMPS
- TURBINE PUMPS
- PETROCHEMICAL PUMPS
- GEARBOX SEALS

SHAFT SIZE: .312" to 5.625"

TEMPERATURES: -75°F to +450°F.

PRESSURE: 75 to 200 PSI

AFLAS is a registered trademark of Asahi Glass Co. Ltd.

Viton is a registered trademark of DuPont.

FEATURES OF SEALS: TYPES A, B, C, D, E, G, Q, W, X

TYPE A (Shaft Sizes 5/16" through 1")

FEATURES: Compact, unitized, single spring, elastomer bellows seal. The factory-assembled, one piece design permits fast, easy installation and the full-convolution elastomer bellows provide maximum flexibility in compensating for shaft movement and wear.

SERVICES: Centrifugal water pumps, deep and shallow well jet pumps, swimming pool pumps and wastewater pumps. Pressures to 75 PSI. Temperature: -40°F to +400°F.



TYPE B (Shaft Sizes 3/8" through 1")

FEATURES: A full-convolution elastomer bellows provide maximum flexibility in compensating for shaft movement while torsional stress on the bellows is controlled by a dent and groove positive drive arrangement.

SERVICES: Small centrifugal water pumps, submersible pumps and swimming pool pumps. Pressures to 75 PSI. Temperature: -40°F to +400°F.



TYPE C (Shaft Sizes 1/2" through 5-1/2")

FEATURES: Elastomer bellows seal, non-clogging, single coil spring, The drive band's notch design eliminates overstressing of the bellows.

SERVICES: Centrifugal, hydraulic, rotary and turbine pumps, compressors, mixers, blenders and chillers. Pressures to 150 PSI. Temperature: -40°F to +400°F.

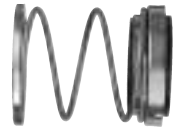

TYPE D, E (Shaft Sizes 1/2" through 5-1/2")

FEATURES: Self adjusting elastomer bellows compensate for abnormal shaft end play and primary face sealing wear. Effects of radial and axial shaft end play are minimized by uniform spring pressure.

Positive drive is transmitted through the drive band and drive notches, which absorb breakout and running torque. Damaging stresses on the elastomer bellows are prevented. Slippage is eliminated, thus protecting shaft and sleeve against wear and scoring. The result is long seal life.

The seal's large single-coil spring is much sturdier than a multiple spring construction design. The spring is non-clogging, self-cleaning and will not foul up due to fluid contact. Corrosion and clogging problems are eliminated.

SERVICES: Used throughout industry in all types of rotary shaft equipment such as pumps, mixers, blenders, agitators and compressors. Seals can be used in an extremely wide range of services from water and steam to chemicals and corrosives. Pressures to 350 PSI. Temperature: -40°F to +400°F.

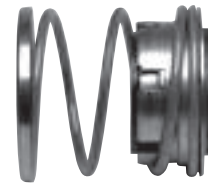

TYPE D

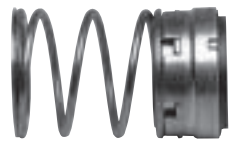

TYPE E

TYPE G (Shaft Sizes 7/16" through 1")

FEATURES: A compact unitized single spring elastomeric bellows shaft seal. Innovative full convolution bellows and interlocking drive band design allows for positive drive and greater tolerance to misalignment. Interference fit of primary ring insures positive drive while avoiding high face distortions associated with crimped designs.

SERVICES: Small centrifugal pumps used in Pool & Spa, Well Water, & HVAC applications. Pressures to 150 PSI. Temperature -20°F to +300°F.



TYPE Q (Shaft Sizes 1/2" through 2-1/4")

FEATURES: Press fitted, rubber diaphragm protects metal components, spring loaded

SERVICES: Icemaker and appliance applications, general purpose food service. Pressures to 30 PSI. Temperature -40°F to +400°F.



TYPE W (Shaft Sizes 1/2" through 6")

FEATURES: Multi Spring, TFE wedge design for use in extreme temperatures / chemical applications. Unitized construction. Also available in a balanced design

SERVICES: Corrosive fluid applications, extreme temperatures. Pressures to 350 PSI. Temperature -75°F to +500°F.



TYPE X (Shaft Sizes 1/2" through 6")

FEATURES: Multi Spring, O ring Design, unitized construction, flexible design compensates for shaft misalignment for high performance and longer seal life. Also available in a balanced design.

SERVICES: Wide usage in chemicals and corrosives. Pressures to 350 PSI. Temperature -20°F to +400°F.



CONVERSION CHART

Fraction	Decimal	mm
1/64	.0156	0.397
1/32	.0312	0.794
3/64	.0468	1.191
1/16	.0625	1.588
5/64	.0781	1.984
3/32	.0937	2.381
7/64	1099	2.778
1/8	.1250	3.175
9/64	.1406	3.572
5/32	.1562	3.969
11/64	.1718	4.366
3/16	.1875	4.763
13/64	.2031	5.159
7/32	.2187	5.556
15/64	.2343	5.953
1/4	.2500	6.350
17/64	.2656	6.747
9/32	.2812	7.144
19/64	.2968	7.541
5/16	.3125	7.938
21/64	.3281	8.334
11/32	.3437	8.731
23/64	.3593	9.128
3/8	.3750	9.525
25/64	.3906	9.922
13/32	.4062	10.319
27/64	.4218	10.716
7/16	.4375	11.113
29/64	.4531	11.509
15/32	.4687	11.906
31/64	.4843	12.303
1/2	.5000	12.700

Fraction	Decimal	mm
33/64	.5156	13.097
17/32	.5312	13.494
35/64	.5468	13.891
9/16	.5625	14.288
37/64	.5781	14.684
19/32	.5937	15.081
39/64	.6093	15.478
5/8	.6250	15.875
41/64	.6406	16.272
21/32	.6562	16.669
43/64	.6718	17.066
11/16	.6875	17.463
45/64	.7031	17.859
23/32	.7187	18.256
47/64	.7343	18.653
3/4	.7500	19.050
49/64	.7656	19.447
25/32	.7812	19.844
51/64	.7968	20.241
13/16	.8125	20.638
53/64	.8281	21.034
27/32	.8437	21.431
55/64	.8593	21.828
7/8	.8750	22.225
57/64	.8906	22.622
29/32	.9062	23.019
59/64	.9218	23.416
15/16	.9375	23.813
61/64	.9531	24.209
31/32	.9687	24.606
63/64	.9843	25.003
1	1.0000	25.400

mm	Inches	mm	Inches
.1	.0039	46	1.811
.2	.0079	47	1.850
.3	.0118	48	1.889
.4	.0157	49	1.929
.5	.0197	50	1.968
.6	.0236	51	2.007
.7	.0276	52	2.047
.8	.0315	53	2.086
.9	.0354	54	2.126
1	.0394	55	2.165
2	.0787	56	2.204
3	.1181	57	2.244
4	.1575	58	2.283
5	.1969	59	2.322
6	.2362	60	2.362
7	.2752	61	2.401
8	.3150	62	2.440
9	.3543	63	2.480
10	.3937	64	2.519
11	.4331	65	2.559
12	.4724	66	2.598
13	.5118	67	2.637
14	.5512	68	2.677
15	.5906	69	2.716
16	.6299	70	2.755
17	.6693	71	2.795
18	.7087	72	2.834
19	.7480	73	2.874
20	.7874	74	2.913
21	.8268	75	2.952
22	.8661	76	2.992
23	.9055	77	3.031
24	.9449	78	3.070
25	.9843	79	3.110
26	1.023	80	3.149
27	1.063	81	3.189
28	1.102	82	3.228
29	1.141	83	3.267
30	1.181	84	3.307
31	1.221	85	3.346
32	1.259	86	3.385
33	1.299	87	3.425
34	1.338	88	3.464
35	1.378	89	3.503
36	1.417	90	3.543
37	1.456	91	3.582
38	1.496	92	3.622
39	1.535	93	3.661
40	1.574	94	3.700
41	1.614	95	3.740
42	1.653	96	3.779
43	1.692	97	3.818
44	1.732	98	3.858
45	1.771	99	3.897
		100	3.937



See Pages 132-141 for Metric Seal Selection

DESIGN AND CONSTRUCTION FEATURES

- SELF ALIGNING
- COMPLETELY ASSEMBLED FOR EASY INSTALLATION
- EXCEPTIONALLY BROAD APPLICATION RANGE
- WIDE TEMPERATURE RANGE
- LOW, MEDIUM OR HIGH PRESSURE APPLICATIONS
- AVAILABLE FOR STANDARD OR LIMITED GLAND DEPTHS
- AUTOMATIC COMPENSATION FOR MATING RING WEAR AND SHAFT END PLAY

ELASTOMETRIC TEMPERATURE LIMITS

(AFLAS® +450° F Buna +225° F EPR +300° F Neoprene +175° F Viton +400° F)

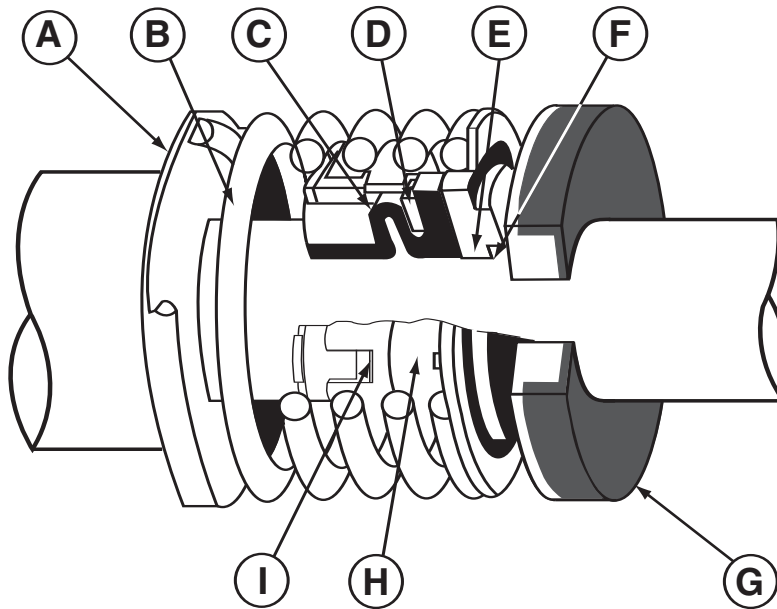

TYPICAL TYPE "D" SEAL PARTS

- | | | | |
|----------|-------------------------------|----------|----------------------|
| A | Spring Holder | F | Lapped Sealing Faces |
| B | Spring | G | Mating Ring Assembly |
| C | Rubber Bellows | H | Retainer |
| D | Disc | I | Drive Band |
| E | Sealing Washer (Primary Ring) | | |

SEAL SIZING GUIDE

1. Remove seal to be replaced from shaft and/or sleeve.
2. Make note of materials used for the old seal parts using U.S. Seal Material Code found on the front cover fold-out.
3. Identify Head type (see front cover fold-out.) Use caliper to measure inside diameter (I.D.) and outside diameter (O.D.)

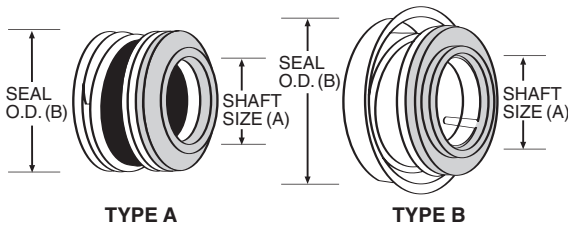

SEAL HEADS – TYPE A and B

Identify seal head type - Determine Shaft Size:
 Measure the inside diameter (I.D.) (dimension A)
 Measure the outside diameter (O.D.) (dimension B)

The operating height is generally the same for all A and B seals of the same shaft size. More positive identification will result from calculating the mating ring dimensions below. If unable to positively identify the seal, consult U.S. Seal Mfg.

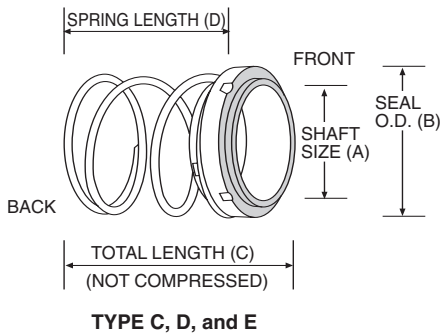

SEAL HEADS – TYPE C, D and E

Identify seal head type - Determine Shaft Size:
 Measure I.D. of the bellows (dimension A) as installed in the seal head.
 Add approximately .016" additional for rubber squeeze.

Measure the head O.D. (dimension B)

Step 1. Measure the total free length (dimension C) of the rotating portion of the assembled seal. (Do not include the seat).

Step 2. Disassemble seal and measure the free length of the spring (dimension D).

Step 3. Take half of the measurement obtained in step 2.

Step 4. Subtract the figure obtained in step 3 from the measurement (dimension C) in step 1. The result is the approximate operating height of the seal.

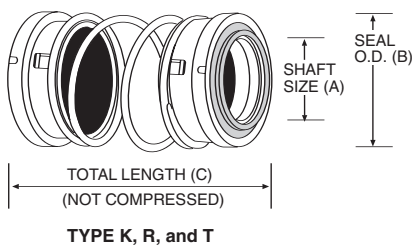

SEAL HEADS – TYPE K, R and T

Identify seal head type - Determine Shaft Size:
 Measure the inside diameter of the bellows (dimension A).
 Add approximately .016" additional for rubber squeeze.

Measure the head O.D. (dimension B)

Calculate the operating height of the seal as follows:

Step 1. Measure the total length of the rotating seal (dimension C). (Not compressed).

Step 2. Multiply the total length (dimension C) by .73. The result is the approximate operating height of the seal.

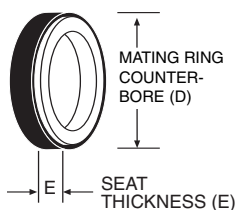

MATING RING and GASKET

Identify the mating ring design from those shown on inside of back cover. Measure O.D. of the gasket while assembled on mating ring and subtract approximately .016" additional for rubber squeeze to obtain counterbore dimension (dimension D).

Measure the combined insert and gasket width (dimension E).

Use the Dimensional Cross Reference by Shaft Size guide (pgs. 79-114) to find the part number of the seal you need, start with Shaft Size and find the line in the tables that matches the dimensions and material code.

HEAD TYPES

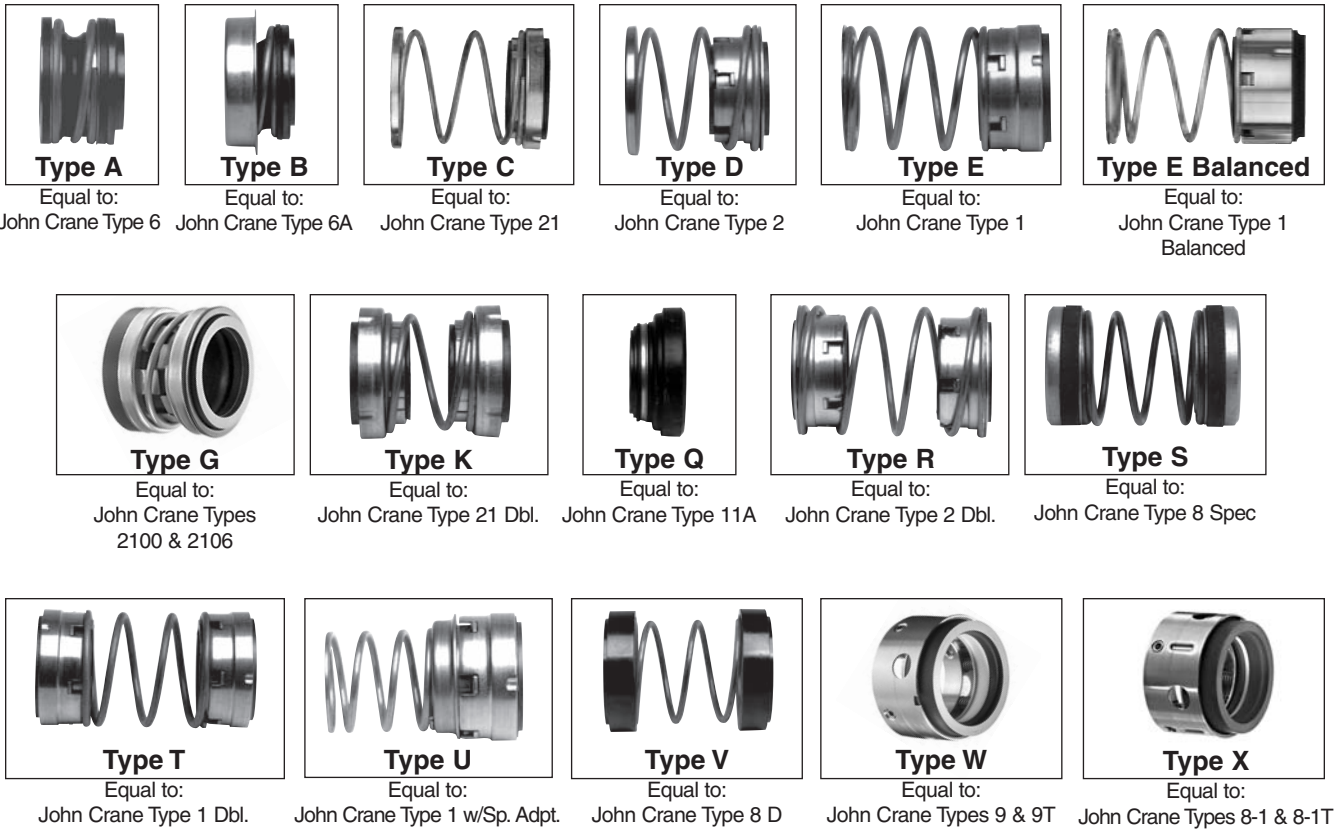

MATING RING DESIGNS

(Available in a wide variety of materials)

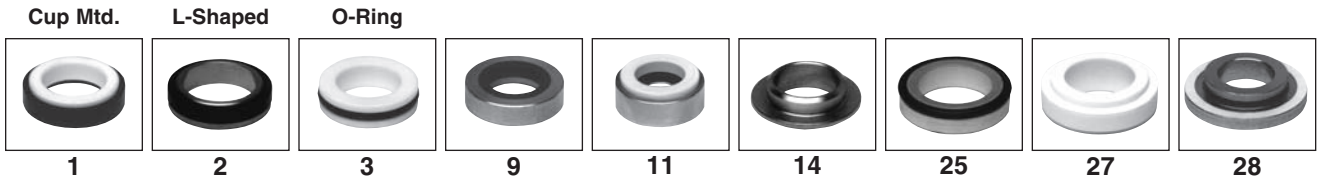

U.S. SEAL MFG. MATERIAL CODE

ELASTOMERS	WASHERS	METAL PARTS	SEATS	SPRINGS
B. Buna	A. Bronze	D. Brass	G. Cast Iron	E. Monel
N. Neoprene	C. Carbon	E. Monel	J. Ceramic	F. Stainless Steel
Q. EPR	H. Glass Filled TFE	F. Stainless Steel	K. Ni-Resist	P. Plated Steel
T. PTFE	L. Silicon Carbide		L. Silicon Carbide	
V. Viton®	M. Molded Plastic		O. Stellite	
X. AFLAS®	R. Silicon Carbide (CVR)		P. Plated Steel	
	S. Toolled Steel		S. Toolled Steel	
	Z. Tungsten Carbide		Z. Tungsten Carbide	

B	C	F	Z	F
Elastomer (Buna)	Washer (Carbon)	Metal Parts (Stainless Steel)	Seat (Tungsten Carbide)	Spring (Stainless Steel)

AFLAS is a registered trademark of Asahi Glass Co. Ltd.
Viton is a registered trademark of DuPont.



PUMP MANUFACTURERS CROSS-REFERENCE

U.S.Seal Part No.	Head	Seat	Seat O.D.	Shaft Dia.	Material Code	Notes	Pump Nameplate Data	MFG. PART #
ABS PUMPS								
PS-851	A	1	1.375	3/4	BCFJF			11107939
PS-267	C	1	2.750	2	BCFJF			11116015
PS-2116	C	3	3.875	3	BCFJF			11116016
ACE ENGINEERING								
PS-633	C	1	1.250	5/8	BCFKF			1743-2CS
PS-112	C	1	1.375	3/4	BCFKF			2043-3CS
ACE PUMP								
PS-100	A	1	1.187	5/8	BMFJF		ACH-25, 33, 50, 75, 100, ACL-75 ACO & BCH-25, 33, 50, 75,	
PS-953	A	1	1.187	5/8	BCFJF			30210F
PS-202	B	11	---	5/8	BMFJF	A	BAC-7B/40110	
PS-1013	B	11	---	5/8	VCFJF	A	BAC-7VT-40150, BAC-7V	40151F
PS-800	C	1	1.156	5/8	BCFJF			
PS-1016	C	1	1.187	5/8	BCDJF	B		
PS-102	D	1	1.250	5/8	BCDKF			2C
PS-201	A	1	1.375	3/4	BMFJF		ACX-H150,ACH150,200,300 & 500 BCH-100, 200, 300	
PS-851	A	1	1.375	3/4	BCFJF			30220F
PS-752	D	1	1.375	3/4	BCDKF			3C
PS-360	A	1	1.625	1	BCFJF		BCH-300, 500, 750, 1000 Models 100S, 133S, 150S, 175S	
PS-1014	A	3	1.625	1	VCFJF		GE-7V-42120	
PS-185V -CMS	C	1	1.875	1 1/4	VCFJF			30265F
ADAMATION, INC.								
PS-3100	N	Spec.	Spec.	1	NMDKF		Champion Dishwasher	75-7050-020
PS-758	C	1	2.125	1-1/2	BCFJF			55-6301-364-6193
ADVANCE								
PS-200	A	1	1.250	5/8	BMFJF			
PS-199	A	8	---	3/4	BMFKF	A		25HZ
ADVANCED PROCESS								
PS-756V	C	3	1.875	1-1/4	VCFKF			90119
ADVANTAGE ENGINEERING								
PS-633V - P66	C	3	1.250	5/8	VCFKF	I		64900000, 6495301
PS-2203	C	3	1.875	1-1/4	QCFKF			6495612
AEROMOTOR PUMPS								
PS-100	A	1	1.187	5/8	BMFJF			17038
PS-200	A	1	1.250	5/8	BMFJF			SJ-45, 17038
PS-274	E	1	1.250	5/8	BCDJF			
PS-487	E	1	1.250	5/8	BCDKF			
PS-201	A	1	1.375	3/4	BMFJF			SJ-47
PS-275	C	1	1.375	3/4	BCFJF			
AG CHEMICAL EQUIPMENT								
PS-360V	A	1	1.625	1	VCFJF			GL-7V
PS-235	C	1	1.625	1	BCFJF			BM-7274
PS-235V	C	3	1.625	1	VCFJF		9MFP, 16PK, CC1-1/2 CC 2-3	BM-7274X
PS-185V	C	3	1.875	1-1/4	VCFJF			513745
PS-756V	C	3	1.875	1-1/4	VCFKF			703225
PS-466	C	1	2.000	1-1/4	BCFJF			BM-7275
PS-446V - CMS	C	1	2.000	1-1/4	VCFJF			BM-7275X
AG TRONICS								
PS-370	A	1	1.625	1	BMFKF			

WHEN SEAL IDENTIFICATION IS DOUBTFUL, SEND SAMPLE ALONG WITH APPLICATION INFORMATION AND ALL PUMP NAMEPLATE DATA.

NOTE: A. MOUNTS ON SHAFT
B. TAPERED SPRING
I. ABRASION RESISTANT CARBON (P66)



PUMP MANUFACTURERS CROSS-REFERENCE

U.S.Seal Part No.	Head	Seat	Seat O.D.	Shaft Dia.	Material Code	Notes	Pump Nameplate Data	MFG. PART #
AIR INJECTOR								
PS-200	A	1	1.250	5/8	BMFJF		SEA-1A, SEA-2A	
AIR-O-LATOR								
PS-618	C	3	1.875	1-1/4	BCFJF			37SM-125CC
PS-758	C	1	2.125	1-1/2	BCFJF			37SM-150CC
ALCO								
PS-193	D	3	2.750	2	NCPGP		Models 244D and 539	2250033-2 5250013-3
ALLIED PUMP								
PS-507	A	1	1.250	5/8	BMFKF			
ALLIS CHALMERS (A-C PUMP Div. of ITT INDUSTRIES)								
PS-150	B	---	---	1/2	BMF-F			45059207
PS-200	A	1	1.250	5/8	BMFJF		Model C1 Close Coupled Pumps	52-104-969-803
							Type: R and RH, CR, HH, RS, DG, DDH,DGH,HHS,RHS,WH.	52-104-969-813
								52-104-969-823
PS-642	B	---	---	5/8	BMF-F			52-105-071-801
PS-118	C	1	1.187	5/8	BCFJF			0618834
PS-359	C	1	1.250	5/8	BCFJF			52-104-945-804
PS-735	D	3	1.250	5/8	BCDJF			52-104-945-805
PS-647	B	---	---	3/4	BMF-F			4386862
PS-358	C	1	1.375	3/4	BCFJF			607986
PS-750	D	1	1.375	3/4	BCDJF			0618321
PS-703	D	1	1.500	7/8	BCDJF			4369006
PS-360	A	1	1.625	1	BCFJF			52-104-969-806
								52-104-969-816
PS-357	C	1	1.625	1	BCFKF			52-113-094-802
PS-252	D	3	1.625	1	BCFKF			52-104-945-804
PS-937	E	---	---	1	BCF-F			52-110-870-809
PS-557	E	3	1.625	1	BCFJF			52-104-870-809
PS-754	E	1	1.625	1	BCFJF			52-110-870-809
PS-1165V	E	3	1.625	1	VCFJF			52-116-831-804/801
PS-276	T	1	1.625	1	BCFJF			52-105-275-808
PS-277	T	1	1.625	1	BCFKF			52-105-275-858
PS-348	C	---	---	1-1/8	BCF-F			71725
PS-356	C	1	1.750	1-1/8	BCFJF			52-104-945-806
PS-355	C	1	1.750	1-1/8	BCFKF			52-104-946-803
PS-605	D	1	1.750	1-1/8	BCFKF			52-104-945-803
PS-254	D	3	1.750	1-1/8	BCFKF			52-104-945-803
PS-204	E	1	1.750	1-1/8	BCFJF		SJH, Size 3 x 2-1/2, 2-1/2 x 2	08-216-526-001
PS-867	E	3	1.750	1-1/8	BCFKF	E		52-104-870-806
PS-185	C	1	1.875	1-1/4	BCFJF			52-113-592-801
PS-756	C	1	1.875	1-1/4	BCFKF			
PS-2122	C	1	1.875	1-1/4	BCFJF			52-114-901-807
PS-466	C	1	2.000	1-1/4	BCFJF			181815
PS-1018	C	3	2.000	1-1/4	BCFKF		Series 2000	52-118-510-801
PS-1018 - EPR	C	3	2.000	1-1/4	QCFKF			52-126-211-801
PS-2200	C	3	2.000	1-1/4	VCFKF	I		52-114-659-808
PS-2230	C	3	2.000	1-1/4	BCFJF			
PS-1015	E	---	---	1-1/4	BCF-F			52-110-870-807
PS-108	E	1	1.875	1-1/4	NCPKP			52-105-383-807
PS-137	E	1	1.875	1-1/4	BCFKF			52-106-609-813
								52-106-609-817
PS-361	E	1	1.875	1-1/4	BCFJF		Model C16 with 215T and Smaller Frame Motors F2L-1, F2L-3, F2L-5 and F2L-6	52-105-609-813 52-104-609-817 52-114-605-805

NOTE: E. LOCK COLLAR SOLD SEPARATELY.
I. ABRASION RESISTANT CARBON (P66)

WHEN SEAL IDENTIFICATION IS DOUBTFUL, SEND SAMPLE ALONG WITH APPLICATION INFORMATION AND ALL PUMP NAMEPLATE DATA.



PUMP MANUFACTURERS CROSS-REFERENCE

U.S. Seal Part No.	Head	Seat	Seat O.D.	Shaft Dia.	Material Code	Notes	Pump Nameplate Data	MFG. PART #
ALLIS CHALMERS (A-C PUMP Div. of ITT INDUSTRIES) (continued)								
PS-546	E	3	1.875	1-1/4	BCFJF			52-104-870-807, S-33
PS-308	T	3	1.875	1-1/4	NCPKF			52-106-286-801
PS-2211	T	3	1.875	1-1/4	BCFJF			52-105-275-801
PS-177	C	1	2.000	1-3/8	BCFJF		MAXEAL®-V Sizes 6 x 4 x 12, 8 x 5 x 12, 8 x 6 x 12	52-115-605-801
PS-210	C	1	2.000	1-3/8	BCFKF		Custom V	52-114-713-801
PS-1667	C	1	2.000	1-3/8	BCFKF		Series 8000	52-117-036-801
PS-2134	C	1	2.000	1-3/8	BCFJF			52-121-998-801
PS-805	C	3	2.000	1-3/8	BCFJF			52-115-605-801
PS-354	E	1	2.000	1-3/8	BCFJF		SS-HH, SS-DH, SS-L, SS-CH	52-111-322-801
PS-677	E	1	2.000	1-3/8	BCFKF			52-105-382-801
PS-677V	E	3	2.000	1-3/8	VCFKF			52-118-679-801
PS-758	C	1	2.125	1-1/2	BCFJF			52-112-870-801
PS-371	D	1	2.125	1-1/2	BCFKF			52-104-946-801 52-101-848-082
PS-382	D	1	2.125	1-1/2	BCFJF			52-104-945-801 52-104-945-806
PS-314	E	3	2.000	1-1/2	BCFJF		Type-SH 4 x 3	08-301-766-066-04
PS-316	E	3	2.000	1-1/2	BCFKF		4 x 2-1/2 SKH	08-301-766-02-036
PS-238	C	1	2.375	1-5/8	BCFJF			52-110-870-811 52-114-043-805
PS-239	C	1	2.375	1-5/8	BCFKF			52-118-511-002 52-118-512-002
PS-1019	C	3	2.625	1-5/8	BCFKF		Series 2000	52-118-510-802
PS-2201	C	3	2.625	1-5/8	QCFKF	I		52-126-211-802
PS-2202	C	3	2.625	1-5/8	BCFJF		Series 2000	52-119-056-802
PS-609	E	1	2.312	1-5/8	BCDJF		Type-KSH	08-303-611-07-001 08-306-539-015-03 52-115-315-801
PS-281	R	3	2.375	1-5/8	BCDKF			
PS-446	C	1	2.500	1-3/4	BCFJF		MAXEAL®-V Series 5000	52-115-605-802
PS-1674	C	1	2.500	1-3/4	BCFKF		Series 8000	52-117-036-802
PS-2135	C	1	2.500	1-3/4	BCFJF			52-121-998-802
PS-317	E	1	2.487	1-3/4	BCFJF		5 x 5 KSG	08-303-611-07-004
PS-205	E	1	2.500	1-3/4	BCFJF		C16, C17S, F2-2, F2-5, F2-8 F2L-2, and F2L-4, MAXEAL VII	08-212-616-001 52-114-901-802
PS-366	E	1	2.500	1-3/4	BCFKF			52-110-871-802
PS-535	E	3	2.500	1-3/4	BCFJF			52-104-870-802 52-114-890-802 52-122-588-806
PS-1197	K	1	2.500	1-3/4	BCFKF			52-117-480-801
PS-1608	C	1	2.625	1-7/8	BCFKF			52-114-713-805
PS-2114	C	3	2.625	1-7/8	BCFJF			52-122-693-805
PS-513	E	1	2.625	1-7/8	BCFKF		3 x 2 MM-2	08-301-766-02-065
PS-523	E	1	2.625	1-7/8	BCFJF		3 x 2 MM-2	
PS-2071	E	3	2.625	1-7/8	BCFJF			52-122-588-814
PS-7884	E Balanced	3	2.500	1-7/8	BCFKF			52-121-754-802
PS-318	K	1	2.625	1-7/8	BCFJF		Models: NSW and NSWV	52-110-280-03-801
PS-1693	K	1	2.625	1-7/8	BCFKF			52-110-280-801
PS-7352	K	1	2.625	1-7/8	BCFKF			52-110-280-807
PS-1105	V	25	2.640	1-7/8	BMFJF		Model F7N-2,4 x 4 x 11	
PS-1017	C	1	2.750	2	BCFKF		Series 8000	52-117-036-803
PS-2133	C	1	2.750	2	BCFJF			52-119-056-803 52-121-998-803
PS-1020	C	3	3.000	2	BCFKF		Series 2000	52-118-510-803

NOTE: I. ABRASION RESISTANT CARBON (P66)

WHEN SEAL IDENTIFICATION IS DOUBTFUL, SEND SAMPLE ALONG WITH APPLICATION INFORMATION AND ALL PUMP NAMEPLATE DATA.



PUMP MANUFACTURERS CROSS-REFERENCE

U.S. Seal Part No.	Head	Seat	Seat O.D.	Shaft Dia.	Material Code	Notes	Pump Nameplate Data	MFG. PART #
ALLIS CHALMERS (A-C PUMP Div. of ITT INDUSTRIES) (continued)								
PS-196	D	---	---	2	BCD-F			52-110-870-803
PS-319	E	1	2.687	2	BCFJF		Series 2000 MAXEAL VII	52-115-315-803 08-212-617-001
PS-478	E	1	2.687	2	BCFKF		MAXEAL® VII and KS	52-110-871-803
PS-477	E	3	2.750	2	BCFKF			52-123-692-801
PS-477V	E	3	2.750	2	VCFKF			52-115-946-803
PS-530	E	3	2.750	2	BCFJF			52-104-870-803 52-116-823-810
PS-2079V	E	3	2.750	2	VCFKF			52-115-946-803
PS-1040	K	3	2.750	2	BCFKF			52-237-862-801
PS-327	E	3	3.000	2-1/8	BCFJF			52-129-172-801
PS-1676	C	3	3.125	2-1/4	BCFKF			52-118-949-802
PS-1678	C	3	3.125	2-1/4	BCFJF			52-122-693-804
PS-323	E	1	3.125	2-1/4	BCDJF		CUSTOM VII, KS, C17, 8 x 8 SH	08-216-036-001
PS-351	E	1	3.125	2-1/4	BCDKF			08-630-132-009
PS-351V	E	3	3.125	2-1/4	VCDKF			52-114-660-804
PS-849	E	3	3.125	2-1/4	BCDKF			52-104-870-804
PS-1688	E	3	3.125	2-1/4	BCFJF			52-122-588-808
PS-279	E	3	3.375	2-1/2	BCFJF		Model F2-6	
PS-349	E	3	3.375	2-1/2	BCFKF			52-104-870-805
PS-349V	E	3	3.375	2-1/2	VCFKF			52-115-946-804
PS-483	C	3	3.500	2-3/4	BCFKF			52-114-713-804
PS-836	C	3	3.500	2-3/4	BCFJF			52-122-693-806
PS-321	E	3	3.500	2-3/4	BCFKF		CUSTOM VII	08-216-035-001 52-104-870-801
PS-838	E	3	3.500	2-3/4	BCFJF			08-210-902-045 52-114-890-810 52-115-315-805
PS-322	K	3	3.500	2-3/4	BCFKF		NSWG, NSWV, Series 300	52-109-719-802
PS-2115	C	3	3.875	3	BCFKF			52-237-805-801
PS-324	E	3	3.875	3	BCDJF		12 x 12 SD	08-210-902-04-037
PS-2141	K	3	3.875	3	BCFKF			52-237-805-801
PS-325	U	3	4.125	3-1/4	BCFKF		10 x 8 SJ	
PS-285	U	3	4.500	3-5/8	BCDKF			08-210-902-03-027
PS-2140	K	3	6.000	5	BCFKF			52-115-055-801 52-238-383-801
ALL POWER MACHINE								
PS-163	B	1	1.000	1/2	BMFJF			
AMERICAN DISH SERVICE								
PS-162	A	1	1.000	1/2	BMFJF			
AMERICAN MACHINE & TOOL								
PS-200	A	1	1.250	5/8	BMFJF			MS-626V
PS-200V - CMS	A	1	1.250	5/8	VCFJF			1640-161-91
PS-642	B	---	---	5/8	BMF-F			
PS-201	A	1	1.375	3/4	BMFJF			MS-756-B
PS-356	C	1	1.750	1-1/8	BCFJF			287-15A/B
AMERICAN MARSH								
PS-112V	C	3	1.375	3/4	VCFKF			890004
PS-633V	C	3	1.250	5/8	VCFKF			890031
AMERICAN PRODUCTS								
PS-150	B	---	---	1/2	BMD-F			
PS-1000	B	1	1.250	5/8	BMFJF		Americana II®, Bronze-Bronze, Eagle® Maxim®, Power-Glass® Eagle®, Ultra-Flo®	39701200 39702000
PS-201	A	1	1.375	3/4	BMFJF		Americana®, Bronze-Noryl®	39500500



PUMP MANUFACTURERS CROSS-REFERENCE

U.S.Seal Part No.	Head	Seat	Seat O.D.	Shaft Dia.	Material Code	Notes	Pump Nameplate Data	MFG. PART #
AMPCO METAL								
PS-357	C	1	1.625	1	BCFKF			500-976
PS-756	C	1	1.875	1-1/4	BCFKF			500-974C
PS-756 - EPR	C	1	1.875	1-1/4	QCFKF			GS 8106850
PS-2122 - P66	C	1	1.875	1-1/4	BCFJF	I		48-1-0341
PS-239	C	1	2.375	1-5/8	BCFKF			500-984
AMPRO-DIACLEAR								
PS-163	B	1	1.000	1/2	BMFJF		Dia Cast, Lexan®-200 Series	AP-504D
PS-1000	B	1	1.250	5/8	BMFJF		Dura-Flo®, Noryl® Turbo, XL600	AP-304D
AMTROL (See THRUSH)								
ANTHONY								
PS-100	A	1	1.187	5/8	BMFJF			04547
PS-1000	B	1	1.250	5/8	BMFJF			04380
APOLLO DENTAL PRODUCTS								
PS-218	A	---	---	5/8	BCF-F			MMS71110
AQUA-CHEM								
PS-358	C	1	1.375	3/4	BCFJF			925-7520
PS-235	C	1	1.625	1	BCFJF			925-7526
PS-251	E	3	1.625	1	BCFKF			925-7509
PS-618	C	3	1.875	1-1/4	BCFJF			925-7563
PS-177	C	1	2.000	1-3/8	BCFJF			925-7523
PS-2114	C	3	2.625	1-7/8	BCFJF			925-7562
AQUA-FLO								
PS-100	A	1	1.187	5/8	BMFJF			
PS-200	A	1	1.250	5/8	BMFJF		Dominator®-High Head Dominator®-Medium Head, Tub-Master®	92500150
PS-200V - CMS	A	1	1.250	5/8	VCFJF			92500152
PS-2131	A	Spec.	---	5/8	BMFJ/MF	G	Flo-Master®, Tub-Master®	91049000
PS-642	B	---	---	5/8	BMF-F			
PS-1021	B	9		5/8	BMFJF	A	K-81159 PU10	
PS-1000	B	1	1.250	5/8	BMFJF		A, B, and D-Series A, C, and D-Series, Dominator® High and Medium head – pre 1995	92509040 92500050
PS-201	A	1	1.375	3/4	BMFJF			
PS-309	C	1	1.500	7/8	BCFJF		AC Series	92500000
PS-361	E	1	1.875	1-1/4	BCFJF			
ARBEE CORP.								
PS-235	C	1	1.625	1	BCFJF			
PS-351	E	1	3.125	2-1/4	BCDKF			
ARMSTRONG PUMP								
PS-392	C	1	.938	1/2	BMFJF			816032-000
PS-401A	C	1	.938	1/2	BCFJF			816706-001, 816549-091
PS-1012	C	1	.938	1/2	BCFJF			
PS-359V - CMS	C	1	1.250	5/8	VCFJF			910134-000
PS-750V	D	3	1.375	3/4	VCDJF			816707-003
PS-752	D	1	1.375	3/4	BCDKF			
PS-978	C	1	1.750	1-1/4	BCFJF	B		825458001 975000-958
PS-979	C	1	1.750	1-1/4	BCFKF	B		
PS-976	D	1	1.750	1-1/4	BCFJF	H		825458-001

WHEN SEAL IDENTIFICATION IS DOUBTFUL, SEND SAMPLE ALONG WITH APPLICATION INFORMATION AND ALL PUMP NAMEPLATE DATA.

NOTE: A. MOUNTS ON SHAFT
 B. TAPERED SPRING.
 G. MOUNTS IN PLASTIC
 H. SPRING HOLDER NOT INCLUDED
 I. ABRASION RESISTANT CARBON (P66)

PUMP MANUFACTURERS CROSS-REFERENCE

U.S.Seal Part No.	Head	Seat	Seat O.D.	Shaft Dia.	Material Code	Notes	Pump Nameplate Data	MFG. PART #
ARMSTRONG PUMP (continued)								
PS-977	D	1	1.750	1-1/4	BCFKF	H		
PS-185 -EPR-P66	C	1	1.875	1-1/4	QCFJF	I		975000-991
PS-2203	C	3	1.875	1-1/4	QCFKF			810150-125
PS-461	D	1	2.375	1-5/8	BCDKF			
PS-514	D	1	2.375	1-5/8	BCDJF			
ARNESON								
PS-200	A	1	1.250	5/8	BMFJF		Pool Sweep	A-8
ATLANTIC FLUIDICS (Div. of TUTHILL VACUUM SYSTEMS)								
PS-1000	B	1	1.250	5/8	BMFJF			
PS-601	B	1	1.375	3/4	BMFJF			
PS-356	C	1	1.750	1-1/8	BCFJF			
PS-185	C	1	1.875	1-1/4	BCFJF			
PS-177	C	1	2.000	1-3/8	BCFJF			
ATLAS								
PS-642	B	---	---	5/8	BMF-F			X8
PS-750	D	1	1.375	3/4	BCDJF			
AURORA PUMP (Div. of PENTAIR PUMP GROUP)								
PS-7520	C	1	1.250	.590	VCFKF	I		712-6444-749
PS-129	D	1	1.250	.590	BCFJF	H	#4 Series Pump	712-0703-750
PS-1675	D	1	1.250	.590	BCFKF	H	14AS114ABF	712-0703-752
PS-100	A	1	1.187	5/8	BMFJF			712-7042-750
PS-2204	A	1	1.250	5/8	VZFFZ			712-2042-767
PS-290	C	1	1.250	5/8	BCFJF		BJ, BJH, BJV, BJF w/ Motors thru 3/4 HP 1750 RPM, Thru 1-1/2 HP 3500 RPM	712-1003-753
PS-633	C	1	1.250	5/8	BCFKF			712-1003-749
PS-358	C	1	1.375	3/4	BCFJF		BJ, BJH, BJV, BJF W/ Motors 1HP 1750 RPM Up, 2 HP 3500 RPM Up. Types: GAPB, GAHA, GAFA, GAVA, Models: GA-4, 5, 6, 7 and 9.	712-1004-753
PS-877V	C	1	1.375	3/4	VCFJF			712-1004-764
PS-2229	C	1	1.375	3/4	BCFKF			712-1004-749
PS-752	D	1	1.375	3/4	BCDKF			712-0705-755
PS-135	D	1	1.500	.787	BCDJF	H	#5 Series Turbine Pump	712-0707-752
PS-614	D	1	1.500	.787	BCDKF	H	#5 Series Pump	712-0707-755
PS-380	D	1	1.625	1	BCFJF			712-0709-754
PS-460	D	1	1.625	1	BCFKF			712-0709-755
PS-355	C	1	1.750	1-1/8	BCFKF			712-0907-749 476-0250-644
PS-356	C	1	1.750	1-1/8	BCFJF		BC, BCH, BCV, BCF and GBH w/ Frames 56 thru 256U. Type: GBHA & GBVA w/Mtr. Frs. 143T, 145T, 182T & 184T. Type: GBPA w/Power Frame 1. Type OJ Power Series, 2 x 2 1/2 x 9-10-12	712-0907-753
PS-2226	C	3	1.750	1-1/8	QCFZF	I		712-0937-769
PS-384	E	1	1.750	1-1/8	BCFKF			712-0454-749
PS-867	E	3	1.750	1-1/8	BCFKF	E		712-0354-756
PS-136	D	1	1.875	1.181	BCDJF	H	#6 Series Turbine Pump	712-0713-754
PS-1179	D	1	1.875	1.181	BCDKF	H	#6 Series Pump	712-0713-755
PS-310	E	1	1.875	1-3/16	BCDJF		GGU, KU, KGG, KCM, KUF, KCMF	712-0305-754
PS-185	C	1	1.875	1-1/4	BCFJF			
PS-137	E	1	1.875	1-1/4	BCFKF		GMC & GAC	712-0306-755
PS-553	C	3	2.125	1-1/2	BCFKF			712-0940-749
PS-2232	C	1	2.125	1-1/2	BCFKF	I		
PS-2209	C	1	2.125	1-1/2	BZFZF			712-0910-678

NOTE: E. LOCK COLLAR SOLD SEPARATELY
H. SPRING HOLDER NOT INCLUDED
I. ABRASION RESISTANT CARBON (P66)

WHEN SEAL IDENTIFICATION IS DOUBTFUL, SEND SAMPLE ALONG WITH APPLICATION INFORMATION AND ALL PUMP NAMEPLATE DATA.



PUMP MANUFACTURERS CROSS-REFERENCE

U.S.Seal Part No.	Head	Seat	Seat O.D.	Shaft Dia.	Material Code	Notes	Pump Nameplate Data	MFG. PART #
AURORA PUMP (Div. of PENTAIR PUMP GROUP) (continued)								
PS-758	C	1	2.125	1-1/2	BCFJF		BC,BCH,BCV &GBH W/MOTOR FR. 284U & Up. GBHA & GBVA W/MTR. FR 213T & Up. OJ Power Series 2.	712-1010-753
PS-712-0910-749	C	1	2.125	1-1/2	BCFKF	I	344ABF	712-0910-749
PS-758V	C	3	2.125	1-1/2	VCFJF			712-0910-764
PS-382	D	1	2.125	1-1/2	BCFJF			712-0718-754
PS-664	E	3	2.375	1-9/16	BCDJF			712-0310-754
PS-436	C	3	2.500	1-3/4	BCFKF			712-1042-749
PS-446	C	1	2.500	1-3/4	BCFJF		Type OJ Power Series #3	712-1012-753
PS-446V-CMS	C	1	2.500	1-3/4	VCFJF			712-1012-764
PS-448-P66	C	1	2.500	1-3/4	BCFKF	I		712-1012-749
PS-267	C	1	2.750	2	BCFJF		Type OJ Power Series #4	712-1014-753
PS-842-P66	C	1	2.750	2	BCFKF	I		712-1014-749
PS-2219	C	1	2.750	2	BZFZF			712-1014-678
PS-267V-CMS	C	3	2.750	2	VCFJF			712-1014-764
PS-332	C	3	2.750	2	BCFKF			712-1044-749
PS-477	E	3	2.750	2	BCFKF			OJ6M
PS-1678	C	3	3.125	2-1/4	BCFJF			712-6478-753
PS-268	C	3	3.250	2-3/8	BCFJF		Type OJ Power Series #5	712-1047-753
PS-268-CMS	C	1	3.250	2-3/8	BCFJF			712-1017-764
PS-492	C	3	3.250	2-3/8	BCFKF			712-1047-749
PS-492-P66	C	3	3.250	2-3/8	BCFKF	I		712-1017-749
PS-269	C	3	3.375	2-1/2	BCFJF		SPHER-Flo Series 4A-4B	712-1048-753 712-1012-739
PS-349	E	3	3.375	2-1/2	BCFKF			712-0468-749
PS-2205	E	3	3.375	2-1/2	BCFKF	I		712-0468-755
PS-270	C	3	3.750	2-7/8	BCFJF		Type OJ Power Series #6	
PS-841	E	3	3.750	2-7/8	BCFKF			712-0471-755
PS-2116	C	3	3.875	3	BCFJF			712-7010-739
PS-272	C	3	4.625	3-3/4	BCFJF		SPHER-Flo Series 5A,5B, 5C, 5D	
BSM PUMP								
PS-185V-CMS	C	1	1.875	1-1/4	VCFJF			466-292-1
BAKER								
PS-100	A	1	1.187	5/8	BMFJF			M1-29-3
BAKER-HYDRO								
PS-200	A	1	1.250	5/8	BMFJF			35B1178
BAKER MFG.								
PS-1050	C	---	---	1/2	BCF-F			E93B
PS-933V	C	---	---	5/8	VCF-F			F93V
PS-208	C	---	---	7/8	BCF-F			H93B
BALDWIN-LIMA-HAMILTON								
PS-371	D	1	2.125	1-1/2	BCFKF			600-28-267
PS-288	D	1	2.500	1-3/4	BCDKF			600-28-284
BANJO PUMP								
PS-601V	B	3	1.375	3/4	VCFJF			127135
PS-245V	C	3	1.625	1	VCFJF			17035
BARNARD-LEAS MFG.								
PS-200V	A	3	1.250	5/8	VCFJF			5-0-17

WHEN SEAL IDENTIFICATION IS DOUBTFUL, SEND SAMPLE ALONG WITH APPLICATION INFORMATION AND ALL PUMP NAMEPLATE DATA.

NOTE: I. ABRASION RESISTANT CARBON (P66)



PUMP MANUFACTURERS CROSS-REFERENCE

U.S.Seal Part No.	Head	Seat	Seat O.D.	Shaft Dia.	Material Code	Notes	Pump Nameplate Data	MFG. PART #
BARNES, JOHN S.								
PS-400	C	---	---	1/2	BMF-F			PA-4947
PS-933	C	---	---	5/8	BCF-F			PA-2408
PS-508	D	1	1.250	5/8	BCDJF			005080
PS-578	D	---	---	7/8	BCD-F			PA-2421
PS-358	C	1	1.375	3/4	BCFJF		3SE2042L	067562
PS-397	C	---	---	1	BCF-F			PA-1525
PS-348	C	---	---	1-1/8	BCF-F			PA-4386
PS-383	D	1	1.875	1-1/4	BCFKF			Y-42
PS-461	D	1	2.375	1-5/8	BCDKF			Y-45
PS-223	D	---	---	1-7/8	BCD-F			PA-3684
BEACH RUSS								
PS-400	C	---	---	1/2	BMF-F			
PS-678	K	---	---	5/8	BCF-F			
PS-564	C	---	---	3/4	BCF-F			
PS-145	K	---	---	3/4	BCF-F			
PS-141	R	---	---	1	BCF-F			
PS-185	C	1	1.875	1-1/4	BCFJF			
BELL & GOSSETT (Div. of ITT INDUSTRIES)								
PS-400A	---	1	.938	1/2	B--J-			118619
PS-400	C	---	---	1/2	BMF-F		Cast Iron 3/4 thru 3 Booster Pumps Type: E and H1 Type: E1, 1-1/4, 1-1/2HV	PZ-3118-118680 PZ-4118
PS-401	C	---	---	1/2	BCF-F			118614
PS-401A	C	1	.938	1/2	BCFJF		For PD-35, PD-37 Series 1522	Kit#3, 186681
PS-392	C	1	.938	1/2	BMFJF		Bronze 3/4 thru 3 Boosters BPD 35, BPD 37-Series 1522- PD 35 & PD 37- Series 60AA 1522 Cast Iron	Kit #7,189102 Kit 118681 3TC29 200AB-F58 189182
PS-393	C	1	.938	1/2	BMFKF			
PS-7712	C	1	1.125	1/2	BMFJF			Kit#20
PS-200	A	1	1.250	5/8	BMFJF			180013
PS-516	A	1	1.250	5/8	BCFJF			DP0304
PS-118	C	1	1.187	5/8	BCFJF			186879, 3530SS
PS-359	C	1	1.250	5/8	BCFJF			180014
PS-2160	C	1	1.250	5/8	BCFJF			DP0302
PS-399	D	---	---	3/4	BCD-F			PW2Z-3188 P-18008-0601
PS-437	D	1	1.275	3/4	BCDJF		1512-PD-39, BPD-39 and 60A	Kit#2,186499, 186433 185260, 172553 DP0294
PS-309	C	1	1.500	7/8	BCFJF			
PS-397	C	---	---	1	BCF-F			
PS-235	C	1	1.625	1	BCFJF			180011, 650PF
PS-398	D	---	---	1	BCF-F			PW1Z-4118
PS-348	C	---	---	1-1/8	BCF-F		Universal Straight thru M Type	PHD-118A
PS-356	C	1	1.750	1-1/8	BCFJF			DP0476, 180017
PS-384	E	1	1.750	1-1/8	BCFKF			
PS-978	C	1	1.750	1-1/4	BCFJF	B	All Iron-Series 1510, 1515, 1531 (Small Frame) Types M1 and M2	Kit#4 & 10 186860,186692, 186862
PS-978 -EPR-TC	C	1	1.750	1.250	QCFZF			P-85070
PS-978V	C	1	1.750	1-1/4	VCFJF	B		186861
PS-979	C	1	1.750	1-1/4	BCFKF	B		Kit#4,10
PS-185-P66	C	1	1.875	1-1/4	BCFJF	I		P70511
PS-185V -CMS	C	1	1.875	1-1/4	VCFJF			186877, P70513
PS-466	C	1	2.000	1-1/4	VCFJF			AC3044
PS-416	D	---	---	1-1/4	BCF-F	H		18689
PS-976	D	1	1.750	1-1/4	BCFJF	H	Series 1510, 1515, 1531 Universal (Small Frame) Types M1 and M2	Kit#1 186680, 185011
PS-977	D	1	1.750	1-1/4	BCFKF	H		Kit#1/Ni-Resist Seat



PUMP MANUFACTURERS CROSS-REFERENCE

U.S.Seal Part No.	Head	Seat	Seat O.D.	Shaft Dia.	Material Code	Notes	Pump Nameplate Data	MFG. PART #
BELL & GOSSETT (Div. of ITT INDUSTRIES) (continued)								
PS-172	C	---	---	1-3/8	BCF-F			AC5228
PS-177	C	1	2.000	1-3/8	BCFJF			52-115-605-801/DP 0298
PS-186	D	1	2.000	1-3/8	BCDKF		VSC 4 x 4x 9-3/4, 5 x 5 x 9-3/4, 5 x 5 x 12, 6 x 6 x 9-3/4	P-77084
PS-186V	D	1	2.000	1-3/8	VCDKF			186834
PS-491	D	1	2.000	1-3/8	BCDJF			186827
PS-224	E	3	2.125	1-1/2	NCFKF			
PS-238	C	1	2.375	1-5/8	BCFJF			186543/186544
PS-461	D	1	2.375	1-5/8	BCDKF			Kit#8/Ni-Resist Seat
PS-514	D	1	2.375	1-5/8	BCDJF		Series 1531, 1510 Universal (Large Frame) M2 and C	Kit#8,186543
PS-2108	C	---	---	1-3/4	BCF-F			AC5229
PS-446V	C	3	2.500	1-3/4	VCFJF			F4992S
PS-237	D	1	2.500	1-3/4	BCDJF			186826
PS-288	D	1	2.500	1-3/4	BCDKF		VSC 6 x 6 x 12, 8 x 8 x 10-1/2 & 13	P-77033
PS-2111	C	---	---	2	BCF-F			AC5230
PS-594	D	3	3.250	2-3/8	BCDKF		VSC 10 x 10 x 13, 12 x 12 x 13	P-81905
PS-834	D	3	3.250	2-3/8	BCDJF		VSC 10 x 10 x 13, 12 x 12 x 13	186828
BENNETT								
PS-400	C	---	---	1/2	BMF-F		541-M-1003	
PS-157	C	---	---	3/4	BCF-F		541-M-1001	
BERKELEY (Also STA-RITE)								
PS-200	A	1	1.250	5/8	BMFJF		New Style Mid-Jet S4 Models: HS,CIMPS, CIMPHS,CIXPS CIXPRS,C1-1/4MPS,B1-1/2APKS, D1-1/2MPKS	S8019,S-20790
PS-516	A	1	1.250	5/8	BCFJF			S-20788 S-20994 S-20789
PS-202	B	11		5/8	BMFJF	A	BM-3081 Mid-Jet49-53 B1MRS, B1MRHS, B1XRHS B1- 1/4MRS, B1-1/2MRS	S-5645,S-16488 S-20990,S-5053 S-20996
PS-1013	B	11	---	5/8	VCFJF	A		S-18150
PS-201	A	1	1.375	3/4	BMFJF		New Style:C1-1/2TPLS, C2TPMS, C2-1/2TPMS,B1-1/2MQKS C2TPMS, C2-1/2TPMS, B1XQHS B1-1/4MQS,B1-1/2MQS	S-5646,S-21961 S-20791 S-20792
PS-201V -CMS	A	1	1.375	3/4	VCFJF			S-18662
PS-921	A	1	1.375	3/4	BMFKF			S-20793,S-32280
PS-851	A	1	1.375	3/4	BCFJF			S-20794,S-21961
PS-973	A	1	1.375	3/4	BCFKF			S-22380
PS-440	B	9		3/4	BMFJF			S-20997
PS-7618	B	11		3/4	BCFJF	***		S-6405
PS-750	D	1	1.375	3/4	BCDJF		Model 142MPKS,1-1/2MQKS	S-5647
PS-752	D	1	1.375	3/4	BCDKF			S-20780
PS-2008	D	1	1.375	3/4	BCFJF			S-20779
PS-360	A	1	1.625	1	BCFJF			S-8742,S-9583 S-20795, S20796
PS-1115	A	1	1.625	1	BCFJF			S-20795,S-20796
PS-460	D	1	1.625	1	BCFKF			S-20781
PS-236	E	1	1.625	1	BCFKF			S-20764,S-20765
PS-754	E	1	1.625	1	BCFJF			S-14867 S-20763
PS-356	C	1	1.750	1-1/8	BCFJF			S-32690
PS-2227	C	1	1.750	1-1/8	BCFJF			S-32689
PS-605	D	1	1.750	1-1/8	BCFKF			S-20783
PS-604	D	1	1.750	1-1/8	BCFJF			S-16812

WHEN SEAL IDENTIFICATION IS DOUBTFUL, SEND SAMPLE ALONG WITH APPLICATION INFORMATION AND ALL PUMP NAMEPLATE DATA.

NOTE: A. MOUNTS ON SHAFT
*** SEAT HAS A SEAT ADAPTER



PUMP MANUFACTURERS CROSS-REFERENCE

U.S.Seal Part No.	Head	Seat	Seat O.D.	Shaft Dia.	Material Code	Notes	Pump Nameplate Data	MFG. PART #
BERKELEY (Also STA-RITE) (continued)								
PS-204	E	1	1.750	1-1/8	BCFJF		BZR, BZQ	S-7216 S-20766
PS-384	E	1	1.750	1-1/8	BCFKF		BZR, BZQ	S-20768,S-20995 S-20767
PS-185	C	1	1.875	1-1/4	BCFJF			S-32014
PS-2122	C	1	1.875	1-1/4	BCFJF			S-32013
PS-381	D	1	1.875	1-1/4	BCFJF		Model 2TPKHS, 3TQKHS, 2TQKIS, 3TQKHS,22TQKHS,2TRKHS	S-5649,S-20785 S-20784
PS-383	D	1	1.875	1-1/4	BCFKF			S-20786
PS-137	E	1	1.875	1-1/4	BCFKF			S-20769,S-15368 S-20772
PS-361	E	1	1.875	1-1/4	BCFJF		All Models A Line Pump except 6YPH, 4EPBL & 6YP	S-5648 S-20770
PS-1185	E	1	1.875	1-1/4	NCPJP			S-20771
PS-883	K	1	1.875	1-1/4	BCFJF			S-39485
PS-305	E	1	2.125	1-1/2	BCFJF		Model 6YPH, 4EPBL, B1-1/2TQLS, B2TQMS,2-1/2TQMS,B3TQMS	S-5650 S-20774
PS-374	E	1	2.125	1-1/2	BCFKF			S-15385
PS-374V	E	3	2.125	1-1/2	VCFKF			S-15538
PS-258	E	3	2.125	1-1/2	BCFKF			S-20773,S-20775
PS-821	D	3	2.375	1-5/8	BCDJF			S-16656
PS-446	C	1	2.500	1-3/4	BCFJF			S-32015
PS-2142	C	1	2.500	1-3/4	BCFJF			S-32692
PS-237	D	1	2.500	1-3/4	BCDJF			S-16768
PS-288	D	1	2.500	1-3/4	BCDKF			
PS-205	E	1	2.500	1-3/4	BCFJF		"A" Line Pump	S-7277,S-20777 S-20776
PS-366	E	1	2.500	1-3/4	BCFKF			
PS-340	C	1	2.625	1-7/8	BCFJF			S-32693,S-32694
PS-593	D	3	2.625	1-7/8	BCDKF			S-20787,S-20993
PS-523	E	1	2.625	1-7/8	BCFJF			S-15213
PS-2069	E	1	2.625	1-7/8	BCFJF			S-20778
PS-2072	E	3	2.625	1-7/8	BCFKF			S-20884
PS-479	E	1	2.750	2	BCFJF			S-13481
PS-338	C	3	3.000	2-1/8	BCFJF			S-32016
PS-353	E	1	3.000	2-1/8	BCFKF			S-16076
PS-537	E	1	3.000	2-1/8	BCFJF			S-15894 S-15950
PS-327	E	3	3.000	2-1/8	BCFJF			S-17274
PS-463	D	3	3.375	2-1/2	BCDKF			S-30320
PS-835	D	3	3.375	2-1/2	BCDJF			S-18337
BLACKMER (DOVER CORP.)								
PS-303	D	1	1.500	7/8	BCDKF			333030
BLAKESLEE CORP.								
PS-235V	C	3	1.625	1	VCFJF		PUMPAKS Models 30-010 thru 30-023	32-036
PS-3401	Q	9		1	NMDKF	A		W-2255
BLUE, JOHN CO.								
PS-879	K	1	1.625	1	BCFJF			S-3565
BOWSER								
PS-564	C	---	---	3/4	BCF-F			27A09
PS-466	C	1	2.000	1-1/4	BCFJF			28A09
BRADEN WINCH								
PS-201	A	1	1.375	3/4	BMFJF			

NOTE: A. MOUNTS ON SHAFT

WHEN SEAL IDENTIFICATION IS DOUBTFUL, SEND SAMPLE ALONG WITH APPLICATION INFORMATION AND ALL PUMP NAMEPLATE DATA.



PUMP MANUFACTURERS CROSS-REFERENCE

U.S.Seal Part No.	Head	Seat	Seat O.D.	Shaft Dia.	Material Code	Notes	Pump Nameplate Data	MFG. PART #
BROWNE & SHARPE								
PS-181	C	20	Plate	5/8	NCPGP		Models 2S, 102 and 220, 225, 240, 245 with 5/8" Shaft	713-9020-270
PS-182	C	20	Plate	3/4	NCPGP		Models #3S, 53, 55, 103	713-9030-270
PS-358	C	1	1.375	3/4	BCFJF			466-142-1
PS-235	C	1	1.625	1	BCFJF			466-137-1
PS-185	C	1	1.875	1-1/4	BCFJF			213-744-274
PS-185 -P66	C	1	1.875	1-1/4	BCFJF	I		713-9245-270
PS-186	D	1	2.000	1-3/8	BCDKF			466-143-1
PS-237	D	1	2.500	1-3/4	BCDJF			213-752-274
BUFFALO PUMPS								
PS-290	C	1	1.250	5/8	BCFJF		Models BPL-BPO-BPM	CC-10900
PS-235	C	1	1.625	1	BCFJF		Models BPL-BPO-BPM	CC-10901
PS-384	E	1	1.750	1-1/8	BCFKF		Model 1-1/2, 2 & 3SL, 1-1/2 & 2SA W/ Solid Shafts, 2-1/2SW	
PS-137	E	1	1.875	1-1/4	BCFKF		1-1/2, 2 & 3SL, SA Sleeved	
PS-354	E	1	2.000	1-3/8	BCFJF			
PS-677	E	1	2.000	1-3/8	BCFKF		Small Frame, Full Ball Brg.	
PS-374	E	1	2.125	1-1/2	BCFKF		4SL, 3SA, 2RR, 284 STAGE, 6SLH & 4HSM	
PS-744	E	1	2.375	1-5/8	BCDKF		5SL, 4S, Lrg. Fr. Full Ball Brg.	13564-6
PS-2110	E	---	---	1-7/8	BCF-F			231-31-413
PS-513	E	1	2.625	1-7/8	BCFKF		6SL, 4RR, 6HSM, 2 STAGE D1 Dbl. Suction, 4SL Extra Heavy	13564-8
PS-350	E	3	3.250	2-3/8	BCFKF		D2 Dbl. Suction Pumps, 6S & 6SU	
PS-349	E	3	3.375	2-1/2	BCFKF		Model 8SL	
BURKS PUMPS (Div. of CRANE PUMPS & SYSTEMS)								
PS-1002	C	1	1.000	1/2	BCFJF			21727
PS-200	A	1	1.250	5/8	BMFJF			17038
PS-290	C	1	1.250	5/8	BCFJF			8514
								17383
PS-290V	C	1	1.250	5/8	VCFJF			9762, 9676, 9652
								3CJSM
PS-1156V	C	3	1.250	5/8	VCFJF			20498-C
PS-2206	C	3	1.250	5/8	QCQKF			20764-C
PS-201	A	1	1.375	3/4	BMFJF			17039
PS-358	C	1	1.375	3/4	BCFJF		Series CS-Turbine Pump	
PS-358V	C	3	1.375	3/4	VCFJF			9813
PS-812	J	1	1.375	3/4	BCFJF			8991
PS-287	J	1	1.500	7/8	BCFJF			
PS-185	C	1	1.875	1-1/4	BCFJF			9917
PS-185V -CMS	C	1	1.875	1-1/4	VCFJF			9926
PS-756 -EPR	C	1	1.875	1-1/4	QCQKF			21271
PS-756V -CMS	C	1	1.875	1-1/4	VCFKF			20500-C
PS-598 -EPR	C	3	1.875	1-1/4	QCQKF			23559
PS-381	D	1	1.875	1-1/4	BCFJF		33066-1-1/2	
PS-238	C	1	2.375	1-5/8	BCFJF			21136
PS-238V -CMS	C	1	2.375	1-5/8	VCFJF			21189
PS-1068	C	1	2.500	1-3/4	BCFKF			M3842-C
BYRON JACKSON								
PS-775	D	3	1.500	7/8	BCDJF		Series 400	D-30903
PS-428	R	1	1.500	7/8	BCDJF		Series 400	D-30904
PS-2033	D	3	1.625	1	BCFJF		Series 513	D-30433
PS-382	D	1	2.125	1-1/2	BCFJF			

WHEN SEAL IDENTIFICATION IS DOUBTFUL, SEND SAMPLE ALONG WITH APPLICATION INFORMATION AND ALL PUMP NAMEPLATE DATA.

NOTE: I. ABRASION RESISTANT CARBON (P66)



PUMP MANUFACTURERS CROSS-REFERENCE

U.S.Seal Part No.	Head	Seat	Seat O.D.	Shaft Dia.	Material Code	Notes	Pump Nameplate Data	MFG. PART #
C.B. TOOL CO. (See LANCASTER PUMP CO.)								
PS-150	B	---	---	1/2	BMF-F			4761
PS-200	A	1	1.250	5/8	BMFJF			2661
PS-201	A	1	1.375	3/4	BMFJF			1661
PS-357	C	1	1.625	1	BCFKF			4400 Series
C.H. & E. MFG.								
PS-200	A	1	1.250	5/8	BMFJF			W-105-7
PS-516	A	1	1.250	5/8	BCFJF			W-108-7A
PS-201	A	1	1.375	3/4	BMFJF			W-105-1
PS-145	K	---	---	3/4	BCF-F			W-105-8
PS-360	A	1	1.625	1	BCFJF			W-105-2
PS-380	D	1	1.625	1	BCFJF			W-105-10
PS-185 -SC-SC	C	1	1.875	1-1/4	BLFLF			W105-15A
PS-659	C	1	2.125	1-1/2	BCFKF			HR-920A
PS-216	K	---	---	1-1/2	BCF-F			P-2271
PS-432	R	1	2.125	1-1/2	BCFKF			W-105-6, W-105-617
PS-449	K	1	2.500	1-3/4	BCFJF			W105-11A
PS-213	R	---	---	1-3/4	BCD-F			
CARTER, RALPH B.								
PS-100	A	1	1.187	5/8	BMFJF			1S-5010
PS-200	A	1	1.250	5/8	BMFJF			1S-5005A, 1S-505
PS-290	C	1	1.250	5/8	BCFJF		Humdinger Pump	1S-5023, 1S-5035
PS-201	A	1	1.375	3/4	BMFJF			1S-5039
PS-360	A	1	1.625	1	BCFJF			2S-5050, 2S-5089 2S-5054, 2S-5112
PS-383	D	1	1.875	1-1/4	BCFKF			3S-5239, 2S-5116 2S-5119
PS-186	D	1	2.000	1-3/8	BCDKF			4S-5151, 4S-5106
PS-553	C	3	2.125	1-1/2	BCFKF			4S-5215
PS-147	D	---	---	1-3/4	BCD-F			4S-5052
PS-237	D	1	2.500	1-3/4	BCDJF			6S-5202
PS-288	D	1	2.500	1-3/4	BCDKF			5S-5029
CARVER								
PS-200	A	1	1.250	5/8	BMFJF		B20-1, B1-2-1-1/4	
PS-359	C	1	1.250	5/8	BCFJF		BB20-1	
PS-201	A	1	1.375	3/4	BMFJF		K1/2, L20-11	
PS-358	C	1	1.375	3/4	BCFJF		Model T14C6	
PS-188	E	1	1.500	7/8	BCFJF			
PS-360	A	1	1.625	1	BMDJF		KN-3LC	
PS-356	C	1	1.750	1-1/8	BCFJF		A300-810	
PS-627	C	1	1.750	1-1/8	BCFJF	B	26C6, 2-1/2YC7, 2YC7, 3YC9	
PS-185	C	1	1.875	1-1/4	BCFJF		K2L-20-9	
PS-185V	C	3	1.875	1-1/4	VCFJF			090-125-01-0103
PS-525	C	3	1.875	1-1/4	BCFKF	B		090-125-01-0104
PS-466	C	1	2.000	1-1/4	BCFJF			090-125-01-0101
PS-381	D	1	1.875	1-1/4	BCFJF		KN-2H-2L-3N	
PS-681	U	1	1.875	1-1/4	BCFJF		1, 1-1/4, 1-1/2, 2, 3, 4L, 1-1/4, 1-1/2, 2, 2-1/2, 3, 4LA 1LB, 1-1/4, 2, 2-1/2, 3, 4H, 1-1/4, 1-1/2, 2, 2-1/2, 3, 4HA	
PS-186	D	1	2.000	1-3/8	BCDKF		4GHC, 4GHB, 4B, 4BB	
PS-745	E	1	2.375	1-5/8	BCDJF			090-162-02-4608
PS-822	E	3	2.375	1-5/8	BCDKF			
PS-1699	E	3	2.375	1-5/8	BCFKF			090-162-02-0236
PS-2207	C	3	2.500	1-3/4	VCFZF			090-175-01-0105
PS-2130	E	3	2.625	1-3/4	BCFJF			
PS-7252	E	1	2.625	1-3/4	BCFJF			090-175-01-0101
PS-477	E	3	2.750	2	BCFKF			



PUMP MANUFACTURERS CROSS-REFERENCE

U.S.Seal Part No.	Head	Seat	Seat O.D.	Shaft Dia.	Material Code	Notes	Pump Nameplate Data	MFG. PART #
CATERPILLAR TRACTOR								
PS-642	B	---	---	5/8	BMF-F			4S-7805
PS-1024	B	---	---	3/4	BCF-F			1N-9177
PS-235	C	1	1.625	1	BCFJF			6N-9313 6N-4743
CENTRAL SCIENTIFIC (CENCO) (HYVAC PRODS.)								
PS-452	B	9		5/8	BMFJF	A		P-35332
PS-441	B	9		3/4	BMFKF	A		P-35334
PS-112	C	1	1.375	3/4	BCFKF			
PS-1026	D	1	1.437	3/4	BCDKF			P-35219
PS-547	C	3	2.000	1-3/8	BCFKF			P-29538
CENTREX								
PS-299	A	---	---	5/8	BMF-F			
PS-360	A	1	1.625	1	BCFJF			201-491,201-493
CHAIN BELT								
PS-201	A	1	1.375	3/4	BMFJF			X7718
PS-578	D	---	---	7/8	BCD-F			X203565
PS-188	E	1	1.500	7/8	BCFJF			X203224
PS-141	R	---	---	1	BCF-F			X6185
PS-154	C	---	---	1-1/4	BCF-F			X7387
PS-185	C	1	1.875	1-1/4	BCFJF			X8023
PS-137	E	1	1.875	1-1/4	BCFKF			X203691
PS-169	K	---	---	1-1/4	BCF-F			X6186
PS-172	C	---	---	1-3/8	BCF-F			X7389
PS-177	C	1	2.000	1-3/8	BCFJF			X2U59-1
PS-209	K	---	---	1-3/8	BCF-F			X6187
PS-223	D	---	---	1-7/8	BCD-F			X7235
PS-593	D	3	2.625	1-7/8	BCDKF			2U59-6
PS-196	D	---	---	2	BCD-F			X7380
CHALLENGE								
PS-642	B	---	---	5/8	BMF-F			
PS-647	B	---	---	3/4	BMF-F			
CHAMPION INDUSTRIES								
PS-3100	N	Spec.	Spec.	Spec.	NMRKF		Head and Seat Self Contained	
CHICAGO PUMP (Div. of YEOMANS CHICAGO CORP.)								
PS-100	A	1	1.187	5/8	BMFJF			2665171
PS-200	A	1	1.250	5/8	BMFJF			2658090
PS-263	D	1	1.187	5/8	BCDKF			266910
PS-750	D	1	1.375	3/4	BCDJF			2655888, 2663071
PS-265	D	3	1.375	3/4	BCDKF			2675337
PS-250	D	3	1.500	7/8	BCDKF			2675339
PS-188	E	1	1.500	7/8	BCFJF			2663072, 2657110
PS-229	E	3	1.500	7/8	BCFKF			267338
PS-380	D	1	1.625	1	BCFJF			2613940, 2663369
PS-252	D	3	1.625	1	BCFKF			2675341
PS-754	E	1	1.625	1	BCFJF			2655887
PS-251	E	3	1.625	1	BCFKF			2675340
PS-604	D	1	1.750	1-1/8	BCDJF			2658071
PS-605	D	1	1.750	1-1/8	BCFKF			2655131
PS-254	D	3	1.750	1-1/8	BCFKF			2675344
PS-253	E	3	1.750	1-1/8	BCFKF			2675343
PS-306	E	1	1.875	1-3/16	BCDJF			2655886
PS-255	E	3	1.875	1-3/16	BCDKF			2675345
PS-361	E	1	1.875	1-1/4	BCFJF			2657093, 2663048
PS-256	E	3	1.875	1-1/4	BCFKF			2675347
PS-264	E	3	1.875	1-1/4	BCFKF			2675318
PS-354	E	1	2.000	1-3/8	BCFJF			2655089
PS-257	E	3	2.000	1-3/8	BCFKF			2675350

WHEN SEAL IDENTIFICATION IS DOUBTFUL, SEND SAMPLE ALONG WITH APPLICATION INFORMATION AND ALL PUMP NAMEPLATE DATA.

NOTE: A. MOUNTS ON SHAFT



PUMP MANUFACTURERS CROSS-REFERENCE

U.S.Seal Part No.	Head	Seat	Seat O.D.	Shaft Dia.	Material Code	Notes	Pump Nameplate Data	MFG. PART #
CHICAGO PUMP (Div. of YEOMANS CHICAGO CORP.) (continued)								
PS-258	E	3	2.125	1-1/2	BCFKF			2675351
PS-259	E	3	2.125	1-1/2	BCFKF			2675352
PS-868	T	1	2.125	1-1/2	BCFJF		VPM-LLC4	
PS-446	C	1	2.500	1-3/4	BCFJF		C3-2-59	117185
PS-262	E	3	2.500	1-3/4	BCFKF		VPM-LMC4	2675354
CLAY EQUIPMENT								
PS-185	C	1	1.875	1-1/4	BCFJF			0-902718-0
PS-758	C	1	2.125	1-1/2	BCFJF			0-902719-0
CLAYTON MARK								
PS-501	A	1	1.250	5/8	BMFJF			29304B
CLEAR WATER, INC.								
PS-163	B	1	1.000	1/2	BMFJF			516069
CLEAVER BROOKS								
PS-358	C	1	1.375	3/4	BCFJF			925-65
CLEVELAND WORM & GEAR								
PS-460	D	1	1.625	1	BCFKF		Reducer 50	Z-1028B
PS-605	D	1	1.750	1-1/8	BCFKF		Reducer 50	Z-1028C
PS-326	D	3	1.937	1-1/4	BCFKF	H	Reducer 70	Z-1028D
PS-331	D	3	2.437	1-5/8	NCPGP			Z-1028F
PS-333	D	3	2.812	2	NCPGP		Reducer 400	Z-1028G
PS-335	D	3	3.375	2-1/2	NCPGP		Reducer 500	Z-1028H
CLIMAX ENGINE								
PS-299	A	---	---	5/8	BMF-F			125-101
PS-380	D	1	1.625	1	BCFJF			
CLOW CORP. (CLOW-YEOMAN)								
PS-185	C	1	1.875	1-1/4	BCFJF			C3-2-57
PS-756V -CMS	C	1	1.875	1-1/4	VCFKF			C3-2-142
PS-2208	C	1	1.875	1-1/4	BZFZF			C3-2-72
PS-383V	D	3	1.875	1-1/4	VCFKF	H		C3-2-12
PS-883	K	1	1.875	1-1/4	BCFJF			C3-2-82
PS-210V	C	3	2.000	1-3/8	VCFKF			C3-2-51
PS-2209	C	1	2.125	1-1/2	BZFZF			C3-2-73
PS-758	C	1	2.125	1-1/2	BCFJF			C3-2-58
PS-436V	C	3	2.500	1-3/4	VCFKF			C3-2-100
PS-446	C	1	2.500	1-3/4	BCFJF			C3-2-59
PS-2210	C	1	2.500	1-3/4	BCFZF			C3-2-93
PS-449	K	1	2.500	1-3/4	BCFJF			C3-2-43
PS-267	C	1	2.750	2	BCFJF			C3-2-60
PS-1145	C	1	2.750	2	VCFKF			C3-2-98
PS-2143	K	1	2.750	2	BCFJF			C3-2-47
PS-844	C	1	3.000	2-1/8	BCFJF			C3-2-83
PS-887	K	1	3.000	2-1/8	BCFJF			C3-2-44
PS-1676V	C	3	3.125	2-1/4	VCFKF			C3-2-99
PS-1679	C	1	3.125	2-1/4	BCFJF			C3-2-61
PS-2158	K	1	3.375	2-1/2	BCFJF			C3-2-53
COLT-AUTOSAN								
PS-754	E	1	1.625	1	BCFJF			97049
CONSOLIDATED DIESEL ELECTRIC								
PS-758	C	1	2.125	1-1/2	BCFJF			0338-0275
CONSTRUCTION MACHINE (CRANE PUMPS & SYSTEMS)								
PS-309	C	1	1.500	7/8	BCFJF			M-3824B
PS-197	K	---	---	7/8	BCF-F			M-3046
PS-235	C	1	1.625	1	BCFJF			M-4292B

NOTE: H. SPRING HOLDER NOT INCLUDED

WHEN SEAL IDENTIFICATION IS DOUBTFUL, SEND SAMPLE ALONG WITH APPLICATION INFORMATION AND ALL PUMP NAMEPLATE DATA.



PUMP MANUFACTURERS CROSS-REFERENCE

U.S.Seal Part No.	Head	Seat	Seat O.D.	Shaft Dia.	Material Code	Notes	Pump Nameplate Data	MFG. PART #
CONSTRUCTION MACHINE (CRANE PUMPS & SYSTEMS) (continued)								
PS-357	C	1	1.625	1	BCFKF		5MPK, 6MFP, 9MFP, 16PK, CC1-1/2-1-1/2, CC1-1/2-2,	M-4292C
PS-235V	C	3	1.625	1	VCFJF			M-4292G
PS-604	D	1	1.750	1-1/8	BCFJF			M-4274C
PS-521	D	2	1.875	1-1/8	BCDKF			
PS-466	C	1	2.000	1-1/4	BCFJF			M-3957C
PS-467	C	1	2.125	1-3/8	BCFKF		Tractor and Industrial Pumps	M-3983C
PS-758	C	1	2.125	1-1/2	BCFJF	H		
PS-448	C	1	2.500	1-3/4	BCFKF			M-3842C
PS-237	D	1	2.500	1-3/4	BCDJF			M-3842C
PS-213	R	---	---	1-3/4	BCD-F			M-2653
PS-1028	C	1	2.750	2	BCFKF			M-4414C
PS-468	D	3	3.250	2-1/2	BCDJF			M-4272B
PS-469	D	3	3.250	2-1/2	BCDKF			M-4272B
CONTINENTAL PUMP								
PS-290	C	1	1.250	5/8	BCFJF			V8-15Q
PS-359	C	1	1.250	5/8	BCFJF			V8-15A, U8-15Q
PS-358V -CMS	C	1	1.375	3/4	VCFJF			U8-56F
COOPER ENERGY SERVICES								
PS-185	C	1	1.875	1-1/4	BCFJF			2-01S-073-003
PS-239	C	1	2.375	1-5/8	BCFKF			2-01S-077-001
CORCORAN CO.								
PS-358V	C	3	1.375	3/4	VCFJF			
CORKEN								
PS-756V	C	3	1.875	1-1/4	VCFKF			2294-XD
CORNELL PUMP								
PS-618	C	3	1.875	1-1/4	BCFJF			A17161P-40
PS-264	E	3	1.875	1-1/4	BCFKF			A15002B-40
PS-546	E	3	1.875	1-1/4	BCFJF			A15002C-40
PS-2211	T	3	1.875	1-1/4	BCFJF			A15002H-40
PS-864	E	3	2.000	1-3/8	BCFJF	E		A15003J-40
PS-821	D	3	2.375	1-5/8	BCDJF			A15005H-40
PS-1697	D	3	2.375	1-5/8	BCFKF			A17064M-40
PS-595	E	3	2.375	1-5/8	BCDJF			A15005D-40
PS-822	E	3	2.375	1-5/8	BCDKF			A1500SC-40
PS-532	C	3	2.750	2	BCFJF			A15007J-40
PS-833	D	3	2.750	2	BCDJF			A15007D-40 A17264P-40
PS-2075	D	3	2.750	2	BCFJF			A15007M-40
PS-530	E	3	2.750	2	BCFJF			A15007B-40
PS-2143	K	1	2.750	2	BCFJF			A15007J-40-225
PS-269	C	3	3.375	2-1/2	BCFJF			A15008R-40
PS-468	D	3	3.250	2-1/2	BCDJF			A15008E-40
PS-279	E	3	3.375	2-1/2	BCFJF			A15008A-40
PS-2158	K	1	3.375	2-1/2	BCDJF			A15008R-40-375
PS-1613	K	3	3.375	2-1/2	BCFJF			A15008R-40
PS-324	E	3	3.875	3	BCDJF			A15009A-40
CRANE-DEMING (Div. of CRANE PUMPS & SYSTEMS)								
PS-106	C	1	1.000	1/2	BCFKF			0058216
PS-1002	C	1	1.000	1/2	BCFJF			0058125
PS-1002V	C	1	1.000	1/2	VCFJF			0055716
PS-493	C	1	1.187	5/8	BCFKF			0006876, 0006841
PS-226	D	1	1.187	5/8	BCDKF			0006875, 0020444
PS-200	A	1	1.250	5/8	BMFJF		Fig. 4910-63, 4357, 4358	0000015

WHEN SEAL IDENTIFICATION IS DOUBTFUL, SEND SAMPLE ALONG WITH APPLICATION INFORMATION AND ALL PUMP NAMEPLATE DATA.

NOTE: E. LOCK COLLAR SOLD SEPARATELY
H. SPRING HOLDER NOT INCLUDED



PUMP MANUFACTURERS CROSS-REFERENCE

U.S. Seal Part No.	Head	Seat	Seat O.D.	Shaft Dia.	Material Code	Notes	Pump Nameplate Data	MFG. PART #
CRANE-DEMING (Div. of CRANE PUMPS & SYSTEMS) (continued)								
PS-200V -CMS	A	1	1.250	5/8	VCFJF			40861
PS-501	A	1	1.250	5/8	BMFJF		4910, 11, 12, 13/ 4963, 66, 67	5/8 Package Seal
PS-507	A	1	1.250	5/8	BMFKF			0009530
PS-507V	A	1	1.250	5/8	VMFKF			8009530
PS-633	C	1	1.250	5/8	BCFKF			115515
PS-201	A	1	1.375	3/4	BMFJF		4910, 4911, 3305, 3352, 4352	0000059
PS-750	D	1	1.375	3/4	BCDJF			
PS-359	C	1	1.250	5/8	BCFJF			0034427
PS-359V -CMS	C	1	1.250	5/8	VCFJF			115835
PS-208	C	---	---	7/8	BCF-F			0006880
PS-687	C	1	1.500	7/8	BCFKF		Fig. 4001	0030877
PS-687V	C	3	1.500	7/8	VCFKF			0084877
PS-309V	C	3	1.500	7/8	VCFJF			0084876
PS-790	D	1	1.437	7/8	BCDJF		Fig. 4001, Dwg. 112-041	0006899
PS-703	D	1	1.500	7/8	BCDJF		Fig. 4001, Dwg. 116-386	0030876
PS-878	K	1	1.500	7/8	BCFKF		Fig. 4001	0030895
PS-892	K	1	1.500	7/8	BCFJF		Fig. 4001	0030894
PS-428	R	1	1.500	7/8	BCDJF		Fig. 4001, Dwg. 113-068	0030894
PS-2145	C	3	1.437	1	BCFJF			0065187
PS-3755	C	3	1.437	1	VCFJF			0075513
PS-235	C	1	1.625	1	BCFJF			0030878
PS-357	C	1	1.625	1	BCFKF		Fig. 4011, Dwg. 115-313	0030879
PS-460	D	1	1.625	1	BCFKF		Fig. 4011	
PS-879	K	1	1.625	1	BCFJF			0030896
PS-891	K	1	1.625	1	BCFKF			0030897
PS-141	R	---	---	1	BCF-F		Fig. 3302-04 #2	0004113
PS-429	R	1	1.625	1	BCFJF			0030896
PS-430	R	1	1.625	1	BCFKF			0030897
PS-608	E	1	1.687	1-1/8	B/V CFKF		Fig. 4012, Size 1A	
PS-384	E	1	1.750	1-1/8	BCDKF			0029177
PS-185	C	1	1.875	1-1/4	BCFJF			0030880
PS-185V -CMS	C	1	1.875	1-1/4	VCFJF			0088458, 0088459
PS-756	C	1	1.875	1-1/4	BCFKF			0030881
PS-756V	C	3	1.875	1-1/4	VCFKF			0084881
PS-598 -TC SEAT	C	3	1.875	1-1/4	BCFZF			8030880
PS-381	D	1	1.875	1-1/4	BCFJF			0030880
PS-383	D	1	1.875	1-1/4	BCFKF		7180	
PS-546	E	3	1.875	1-1/4	BCFJF		Models AVS	0078876, 0078879
PS-883	K	1	1.875	1-1/4	BCFJF			0030898
PS-890	K	1	1.875	1-1/4	BCFKF			0030899
PS-1187	T	1	1.875	1-1/4	BCFJF			0045935
PS-186	D	1	2.000	1-3/8	BCDKF			0030882
PS-209	K	---	---	1-3/8	BCF-F			0006905
PS-2234	E	3	2.062	1-7/16	BCFKF		Model 1523, 1535	0036636
PS-758	C	1	2.125	1-1/2	BCFJF			0030884
PS-659	C	1	2.125	1-1/2	BCFKF		Fig. 4021HD	0030885
PS-659V -CMS	C	1	2.125	1-1/2	VCFKF			0084885
PS-2209	C	1	2.125	1-1/2	BZFZF			8030885
PS-382	D	1	2.125	1-1/2	BCFJF		Fig. 4021HD	
PS-541	K	1	2.125	1-1/2	BCFJF			0030900
PS-884	K	1	2.125	1-1/2	BCFKF			0030901
PS-431	R	1	2.125	1-1/2	BCFJF			0030900
PS-432	R	1	2.125	1-1/2	BCFKF			0030901
PS-238	C	1	2.375	1-5/8	BCFJF			0030886



PUMP MANUFACTURERS CROSS-REFERENCE

U.S.Seal Part No.	Head	Seat	Seat O.D.	Shaft Dia.	Material Code	Notes	Pump Nameplate Data	MFG. PART #
CRANE-DEMING (Div. of CRANE PUMPS & SYSTEMS) (continued)								
PS-238V -CMS	C	1	2.375	1-5/8	VCFJF			0106330
PS-239	C	1	2.375	1-5/8	BCFKF			0030887
PS-239V -CMS	C	1	2.375	1-5/8	VCFKF			0106331
PS-514	D	1	2.375	1-5/8	BCDJF			0030889
PS-446	C	1	2.500	1-3/4	BCFJF		Model 7360	0030888
PS-2207	C	3	2.500	1-3/4	VCFZF			0117779
PS-237	D	1	2.500	1-3/4	BCDJF			
PS-535	E	3	2.500	1-3/4	BCFJF		Model 3065	0078877, 0078882
PS-449	K	1	2.500	1-3/4	BCFJF		Fig. 7182-Fig. 4031	30904
PS-213	R	---	---	1-3/4	BCD-F			0006906
PS-2144	T	3	2.500	1-3/4	BCFJF			0045936
PS-340	C	1	2.625	1-7/8	BCFJF			0046389
PS-1608	C	1	2.625	1-7/8	BCFKF			0046390
PS-312	C	3	2.625	1-7/8	BCFKF			0046390
PS-543	C	3	3.000	2-1/8	BCFKF			0030891 425650999
PS-543V	C	3	3.000	2-1/8	VCFKF			0119412
PS-353	E	2	3.000	2-1/8	BCFKF			
PS-2086	E	3	3.000	2-1/8	BCFKF			
PS-2126	T	3	3.000	2-1/8	BCFJF			0045937
PS-1676	C	3	3.125	2-1/4	BCFKF			0030893
PS-1676V	C	3	3.125	2-1/4	VCFKF			75520
PS-1678	C	3	3.125	2-1/4	BCFJF			0030892
CREPACO								
PS-397	C	---	---	1	BCF-F			549-S-6407F
PS-397V	C	---	---	1	VCF-F			549-S-6408F
PS-154	C	---	---	1-1/4	BCF-F			549-S-6407
CURTIS								
PS-605	D	1	1.750	1-1/8	BCFKF			
PS-288	D	1	2.500	1-3/4	BCDKF			RMB-414
DAKON								
PS-150	B	---	---	1/2	BMF-F		Seat is Impeller	
DARLEY, W.S. & COMPANY								
PS-448	C	1	2.500	1-3/4				1842300
DAYTON (See TEEL PUMP)								
DEAN BROTHERS (See MET PRO CORPORATION)								
DECATUR PUMP (Also BURKS PUMPS)								
PS-501	A	1	1.250	5/8	BMFJF			20888
PS-359	C	1	1.250	5/8	BCFJF			
PS-290	C	1	1.250	5/8	BCFJF			8514
PS-290V	C	1	1.250	5/8	VCFJF			9762
PS-358	C	1	1.375	3/4	BCFJF			8991
PS-750	D	1	1.375	3/4	BCDJF			
PS-185	C	1	1.875	1-1/4	BCFJF			9917
PS-185V	C	3	1.875	1-1/4	VCFJF			9926
PS-598 -EPR	C	3	1.875	1-1/4	QCFKF			21271



PUMP MANUFACTURERS CROSS-REFERENCE

U.S.Seal Part No.	Head	Seat	Seat O.D.	Shaft Dia.	Material Code	Notes	Pump Nameplate Data	MFG. PART #
DELAVAL								
PS-2138	C	Spec	1.360	1/2	BCFGF			PP-046JCE
PS-752	D	1	1.375	3/4	BCDKF			PP-046DP, PP-046DE
PS-687	C	1	1.500	7/8	BCFKF			PP-046H
PS-357	C	1	1.625	1	BCFKF			PP-046JAZ
PS-499	C	3	1.625	1	BCFKF			PP-046JKN
PS-499 -EPR	C	3	1.625	1	QCCKF			PP-046JFZ
PS-1034	C	28	2.440	1	BCFKF			PP-046JM
PS-460	D	1	1.625	1	BCFKF			PP-046BH, PP-046D PP-046FBV
PS-159	D	3	1.625	1	NCPGP			
PS-236	E	1	1.625	1	BCFKF			
PS-605	D	1	1.750	1-1/8	BCFKF			PP-046L
PS-2162	C	1	1.875	1-3/16	BCFKF			PP-046JDC
PS-1044	C	28	2.834	1-3/16	BCFKF			PP-046JL
PS-756	C	1	1.875	1-1/4	BCFKF			PP-046JAT
PS-1036	C	28	2.835	1-1/4	BCFKF			PP-046JH
PS-1036V	C	28	2.835	1-1/4	VCFKF			PP-046JN
PS-467	C	1	2.125	1-3/8	BCFKF			
PS-186	D	1	2.000	1-3/8	BCDKF		S-1146C, S-1146CB, S-1446B	PP-046JCL
PS-659	C	1	2.125	1-1/2	BCFKF			PP-046JBK
PS-371	D	1	2.125	1-1/2	BCFKF			PP-046DAA, PP-046D
PS-239	C	1	2.375	1-5/8	BCFKF			PP-046JBC
PS-1035	C	28	3.544	1-5/8	BCFKF			PP-046JK
PS-1039	C	28	3.544	1-5/8	VCFKF			PP-046JR
PS-461	D	1	2.375	1-5/8	BCDKF			PP-046DR
PS-448	C	1	2.500	1-3/4	BCFKF			PP-046JAY
PS-1038	C	28	3.544	1-3/4	BCFKF			PP-046JG
PS-288	D	1	2.500	1-3/4	BCDKF			PP-046BM
PS-593	D	3	2.625	1-7/8	BCDKF			PP-046DB
PS-842	C	1	2.750	2	BCFKF			PP-046JBB
PS-1037	C	28	4.330	2	BCFKF			PP-046JJ
PS-1037V	C	28	4.330	2	VCFKF			PP-046JP
PS-462	D	1	2.750	2	BCDKF			PP-046DC, PP-046BP PP-046DCA
PS-353	E	2	3.000	2-1/8	BCFKF			
PS-1679	C	1	3.125	2-1/4	BCFJF			PP-046JCD
PS-492	C	3	3.250	2-3/8	BCFKF			PP-046JBA
PS-1677	C	28	5.118	2-3/8	BCFKF			PP-046FBY PP-046JBH
PS-594	D	3	3.250	2-3/8	BCDKF			PP-046BN
PS-483	C	3	3.500	2-3/4	BCFKF			PP-046JAL
DELAVAL MFG. & CO.								
PS-1061	A	1	1.250	9/16	VCFJF			34943
DEMING (See CRANE DEMING)								
DEMPSTER INDUSTRIES								
PS-162	A	1	1.000	1/2	BMFJF			
PS-200	A	1	1.250	5/8	BMFJF			907-06030
PS-260	B	11		5/8	BMFJF	A		
PS-441	B	9		3/4	BMFKF	A	Utility Pump	907-06001
PS-440	B	11		3/4	BMFJF	A	PrimoJet® and Convento Jet	907-06006
PS-358	C	1	1.375	3/4	BCFJF			907-06043
PS-309	C	1	1.500	7/8	BCFJF			907-06033
PS-309V	C	3	1.500	7/8	VCFJF			907-06034
PS-598	C	3	1.875	1-1/4	BCFKF			907-06035
PS-756V	C	3	1.875	1-1/4	VCFKF			907-06046



PUMP MANUFACTURERS CROSS-REFERENCE

U.S.Seal Part No.	Head	Seat	Seat O.D.	Shaft Dia.	Material Code	Notes	Pump Nameplate Data	MFG. PART #
DENISON DIV. (ABEX CORP.)								
PS-201	A	1	1.375	3/4	BMFJF			622-03102
PS-294	C	1	1.562	7/8	BCFKF		Model TMC	
PS-297	D	1	1.875	1-3/16	NCPJP			622-03101
PS-467	C	1	2.125	1-3/8	BCFKF		20-21422 Series	
PS-353	E	2	3.000	2-1/8	BCFKF			M-800
PS-351	E	1	3.125	2-1/4	BCDKF		40 Series	
DETROIT HARVESTER HOWELL								
PS-298	A	---	---	1/2	BMF-F			3-6
PS-299	A	---	---	5/8	BMF-F		H,SM-F,PM,1/4HP,-New style replaces Old Style Eared Carbon. Seat is Impeller.	4-6
PS-100	A	1	1.187	5/8	BMFJF			
DEVILBISS								
PS-508	D	1	1.250	5/8	BCDJF			QM-4507
PS-358	C	1	1.375	3/4	BCFJF			QM-4509
PS-752	D	1	1.375	3/4	BCDKF			QMW-4509
DIXIE PUMP								
PS-200	A	1	1.250	5/8	BMFJF			
PS-201	A	1	1.375	3/4	BMFJF			
DOERR								
PS-359	C	1	1.250	5/8	BCFJF			
DOMESTIC PUMP								
PS-200	A	1	1.250	5/8	BMFJF			180013
PS-359	C	1	1.250	5/8	BCFJF			180014
PS-201	A	1	1.375	3/4	BMFJF			
PS-358	C	1	1.375	3/4	BCFJF			180010
PS-360	A	1	1.625	1	BCFJF			
PS-235	C	1	1.625	1	BCFJF			180011
PS-177	C	1	2.000	1-3/8	BCFJF			180015
DOUGHBOY INDUSTRIES (Div. of HOFFINGER INDUSTRIES)								
PS-671	B	1	.875	3/8	BMDJF			306-1003
PS-642	B	---	---	5/8	BMF-F			308-1264
PS-202	B	11		5/8	BMFJF	A		306-1001
DOUGLAS MOTOR CORP.								
PS-201	A	1	1.375	3/4	BMFJF			47406
PS-210	C	1	2.000	1-3/8	BCFKF			46154
DOWDELL CO., J.L. (DOWCO PUMP)								
PS-260	B	11		5/8	BMFJF	A		D1101S-5/8
PS-440	B	11		3/4	BMFJF	A		D1101S-3/4
DRESSER INDUSTRIES (LEROI DIV.)								
PS-200	A	1	1.250	5/8	BMFJF			125-101/113-1
PS-618	C	3	1.875	1-1/4	BCFJF			
PS-1062	C	3	2.125	1-3/8	VCFGF			
PS-436V	C	3	2.500	1-3/4	VCFKF			125-693-2
DUFF NORTON								
PS-933	C	---	---	5/8	BCF-F			732015C
DUNHAM, C.A.								
PS-508	D	1	1.250	5/8	BCDJF		Model D	614
DUNHAM-BUSH (MEPCO: Marshall Engineered Products Co.)								
PS-106	C	1	1.000	1/2	BCFKF			996 New
PS-632	C	1	1.000	1/2	BCFKF			996 Old
PS-118	C	1	1.187	5/8	BCFJF			
PS-359	C	1	1.250	5/8	BCFJF			S-472
PS-633	C	1	1.250	5/8	BCFKF			472
PS-487	E	1	1.250	5/8	BCDKF			

WHEN SEAL IDENTIFICATION IS DOUBTFUL, SEND SAMPLE ALONG WITH APPLICATION INFORMATION AND ALL PUMP NAMEPLATE DATA.

NOTE: A. MOUNTS ON SHAFT



PUMP MANUFACTURERS CROSS-REFERENCE

U.S.Seal Part No.	Head	Seat	Seat O.D.	Shaft Dia.	Material Code	Notes	Pump Nameplate Data	MFG. PART #
DUNHAM-BUSH (MEPCO: Marshall Engineered Products Co.) (continued)								
PS-982	C	1	1.625	1	BCFKF			860
PS-499	C	3	1.625	1	BCFKF			GA-1781-4
PS-983	C	1	1.750	1-1/8	BCFKF		ApD705	861, ML-8702
PS-756	C	1	1.875	1-1/4	BCFKF			3179
PS-756V-CMS	C	1	1.875	1-1/4	VCFKF			S-5548
PS-239	C	1	2.375	1-5/8	BCFKF			3291 (A2-4066)
DURIRON (DURCO)								
PS-866	E	3	1.750	1-1/8	BCFJF			
PS-867	E	3	1.750	1-1/8	BCFKF	E		
PS-886	T	3	1.750	1-1/8	BCFJF			
PS-918	T	3	1.750	1-1/8	BCFJF			
PS-523	E	1	2.625	1-7/8	BCFJF			
PS-586	E	3	2.625	1-7/8	BCFKF			
PS-742	T	1	2.625	1-7/8	BCFJF			
PS-743	T	1	2.625	1-7/8	BCFKF			
DURO								
PS-452	B	9		5/8	BMFJF	A		5486
PS-102	D	1	1.250	5/8	BCDKF		Model DV-30, 50, 70, 100, VX-30, 50,70,100 DJ-70,100 S J70,100	B-170
PS-508	D	1	1.250	5/8	BCDJF			5485
EAST SIDE MFG.								
PS-100	A	1	1.187	5/8	BMFJF			P28322
PS-200	A	1	1.250	5/8	BMFJF			
PS-1000	B	1	1.250	5/8	BMFJF		Model BTH	
PS-359	C	1	1.250	5/8	BCFJF			
PS-201	A	1	1.375	3/4	BMFJF			
PS-358	C	1	1.375	3/4	BCFJF			
PS-750	D	1	1.375	3/4	BCDJF			MF-1
PS-360	A	1	1.625	1	BCFJF		Series C, CM and CH	P-28175
EASTERN ENGINEERING (See PULSAFEEDER)								
EATON CORP. (See CLEVELAND WORM & GEAR)								
ECONOMY PUMP								
PS-100	A	1	1.187	5/8	BMFJF			
PS-360	A	1	1.625	1	BCFJF			
PS-1067	E	1	1.875	1-1/8	BCFKF		2 x 2 MD	
EDWARDS ENGINEERING								
PS-3578V	C	1	1.175	7/16	VCFJF			C-316
PS-348V	E	3	1.750	1-1/8	VCDKF			220000
ELECTROMOTIVE DIV.								
PS-632	C	1	1.000	1/2	BCFKF			822832
PS-602	D	1	1.562	7/8	BCDJF			5876888
ELKINGTON DISHWASHER								
PS-3440	C	1	1.750	1	BCFJF		DT Series	
ENVIRONMENT ONE								
PS-2033	D	3	1.625	1	BCFJF			A-2021B110
ENPO-CORNELL								
PS-961	B	1	1.250	5/8	BCFJF			
PS-452	B	9		5/8	BMFJF	A		
PS-201	A	1	1.375	3/4	BMFJF			
PS-360	A	1	1.625	1	BCFJF			
PS-466	C	1	2.000	1-1/4	BCFJF			M-3957-F

NOTE: A. MOUNTS ON SHAFT
E. LOCK COLLAR SOLD SEPARATELY

WHEN SEAL IDENTIFICATION IS DOUBTFUL, SEND SAMPLE ALONG WITH APPLICATION INFORMATION AND ALL PUMP NAMEPLATE DATA.



PUMP MANUFACTURERS CROSS-REFERENCE

U.S.Seal Part No.	Head	Seat	Seat O.D.	Shaft Dia.	Material Code	Notes	Pump Nameplate Data	MFG. PART #
ENPO-CORNELL (continued)								
PS-546	E	3	1.875	1-1/4	BCFJF			
PS-467	C	1	2.125	1-3/8	BCFKF			M-3983-C
PS-1683	E	3	2.375	1-5/8	BCFJF			
PS-1068	C	1	2.500	1-3/4	BCFKF			M-3842C
PS-2212	C	1	2.500	1-3/4	BCFJF			M-3842F
PS-449	K	1	2.500	1-3/4	BCFJF			
PS-267	C	1	2.750	2	BCFJF			M-4414F
PS-842	C	1	2.750	2	BCFKF			M-4414C
PS-2139	C	1	2.750	2	BCFJF			M 4414F
PS-1040	K	3	2.750	2	BCFKF			
PS-1041	K	3	3.250	2-3/8	BCFKF			
PS-1613	K	3	3.375	2-1/2	BCFKJF			
ESSICK								
PS-358	C	1	1.375	3/4	BCFJF			9014009
PS-175	K	1	1.375/1.500	3/4	BCFJF			9014225
PS-185	C	1	1.875	1-1/4	BCFJF			9014025
PS-177	C	1	2.000	1-3/8	BCFJF			9014027
PS-495	K	1	2.000	1-3/8	BCFJF			9014140
EVERITE								
PS-150	B	---	---	1/2	BMF-F		Seat Is Impeller	1205
PS-200	A	1	1.250	5/8	BMFJF			2544
PS-501	A	1	1.250	5/8	BMFJF			
PS-359	C	1	1.250	5/8	BCFJF			2584
FAIRBANKS MORSE (Div. of PENTAIR)								
PS-506	A	1	1.000	1/2	BMFKF		Models: 49 and 59 Circulating Pumps	91325
PS-200	A	1	1.250	5/8	BMFJF		Model H, HC, HV	82480-75, 82723
PS-501	A	1	1.250	5/8	BMFJF		H500, 649, 650 Shallow Well and All Model 49 Ejectors to 1 HP. Models 300, 500 and 750 VS-VD	S625, 82635-60 82702-75
PS-507	A	1	1.250	5/8	BMFKF		For UL 25 Westco Shallow Well	82480-60, 82764-60
PS-359	C	1	1.250	5/8	BCFJF		4 Submersible Motor	
PS-102	D	1	1.250	5/8	BCDKF			82698
PS-508	D	1	1.250	5/8	BCDJF		Model 49	82480-75
PS-201	A	1	1.375	3/4	BMFJF		Model AC, AEC, AS, AES	
PS-877	C	1	1.375	3/4	BCFJF		Model 5553B-Build Together Pump- All Metal Parts Chrome Plated	HYDE-2, 82738-60
PS-750	D	1	1.375	3/4	BCDJF			40088878
PS-188	E	1	1.500	7/8	BCFJF		1-1/4 Fig. 5553E, Motor Frame up to 184	HYD1Q1
PS-229	E	3	1.500	7/8	BCDKF			WESTCO BR545
PS-235	C	1	1.625	1	BCFJF			CND-1726D-1726C
PS-356	C	1	1.750	1-1/8	BCFJF		1-1/2,2,3,4 Fig.5553N, Frm. 213 and Up	HYD1AC
PS-204	E	1	1.750	1-1/8	BCFJF		1-1/4 Fig. 5553E, Mtr. Frm. 213 and Up	HYD1Q2
PS-185	C	1	1.875	1-1/4	BCFJF			HYD1AC2
PS-381	D	1	1.875	1-1/4	BCFJF			WESTCO 2G
PS-510	D	1	2.000	1-1/4	BCFJF	H	Model 5554 and 5554A Pump	HYD1E2
PS-890	K	1	1.875	1-1/4	BCFKF			HYD1AD2
PS-354	E	1	2.000	1-3/8	BCFJF			HYD1 Q3
PS-1104	V	25	2.140	1-3/8	BCFJF		Frame 25	HYD1S3
PS-305	E	1	2.125	1-1/2	BCFJF			ND-2502-A1
PS-395	E	3	2.125	1-1/2	BCFJF		3" & 4" Fig. 5821, 2" & 3" Fig. 5822, 2" & 2-1/2" Fig. 5823, 3" Fig. 5874A	HYD1AA1
PS-515	E	3	2.250	1-1/2	BCFJF		2" Fig. 5812, 3", 4" Fig. 5811	HYD1A2
PS-514	D	1	2.375	1-5/8	BCDJF			ND1246-A4
PS-446	C	1	2.500	1-3/4	BCFJF			HYD1AC3, HYD1AD1
PS-550	C	3	2.500	1-3/4	BCFJF			HYD1CB2
PS-449	K	1	2.500	1-3/4	BCFJF		Model 5421 BP, KTPA-10031	HYD1AD7, HYD1AD1
PS-1070	U	3	2.375	1-3/4	BCFJF		5" Fig. 5821, 6" Fig. 5821, 4" Fig. 5822, 3" Fig. 5823, 4" Fig. 5874A, 3" Fig. 5876A, 2" Fig. 5972A, 2-1/2" Fig. 5972A	HYD1AA3

WHEN SEAL IDENTIFICATION IS DOUBTFUL, SEND SAMPLE ALONG WITH APPLICATION INFORMATION AND ALL PUMP NAMEPLATE DATA.

NOTE: H. SPRING HOLDER NOT INCLUDED



PUMP MANUFACTURERS CROSS-REFERENCE

U.S. Seal Part No.	Head	Seat	Seat O.D.	Shaft Dia.	Material Code	Notes	Pump Nameplate Data	MFG. PART #
FAIRBANKS MORSE (Div. of PENTAIR) (continued)								
PS-519	U	3	2.500	1-3/4	BCFJF		Fig. 5822A, Size 4	HYD1T2
PS-513	E	1	2.625	1-7/8	BCFKF			HYD1Q4
PS-523	E	1	2.625	1-7/8	BCFJF			HYD1Q4, HYD1E4
PS-898	U	3	2.500	1-7/8	BCFJF		8" Fig. 5821, 5" & 6" Fig. 5822, 4" & 5" Fig. 5823, 5" Fig. 5874A	HYD1AA4
PS-2146	V	3	2.625	1-7/8	BMFJF			HYD1S16
PS-1105	V	25	2.640	1-7/8	BMFJF		Frame 28	HYD1S4
PS-332	C	3	2.875	2	BCFKF			HYD1BX1
PS-530	E	3	2.750	2	BCFJF			HYD1BG2
PS-2143	K	1	2.750	2	BCFJF			HYD1AD8
PS-338	C	3	3.000	2-1/8	BCFJF		Frame 30 Model 5500	HYD1AC4
PS-353	E	1	3.000	2-1/8	BCFKF			HYD1E4
PS-327	E	3	3.000	2-1/8	BCFJF			HYD1Q5
PS-887	K	1	3.000	2-1/8	BCFJF			HYD1AD3
PS-1102	V	25	3.140	2-1/8	BCFJF		Frame 32	HYD1S5
PS-1107	V	25	3.187	2-1/8	BCFJF		Frame 32	HYD1S
PS-853	C	3	3.375	2-1/2	BCFKF	E		HYD1BX3
PS-279	E	3	3.375	2-1/2	BCFJF		8" Fig. 5822, 6" & 8" Fig. 5823, 5" & 6" Fig. 5824, 5" Fig. 5972	HYD1AA6
PS-1613	K	3	3.375	2-1/2	BCFJF			HYD1AD10
PS-2147	V	3	3.500	2-1/2	BCFJF			HYD1S17, HYD1CW2
PS-328	E	3	3.375	2-5/8	BCFJF			HYD1Q6
PS-542	E	3	3.375	2-5/8	BCFKF	E		HYD1Q6
PS-2148	K	3	3.500	2-3/4	BCFJF			HYD1AD11
PS-329	E	3	3.750	2-7/8	BCFJF			HYD1Q7
PS-2115	C	3	3.875	3	BCFKF			HYDICE3
PS-7215	V	3	4.000	3	BCFJF			HYD1S18
PS-1069	V	3	4.750	3-1/8	BCFJF			HYD1S8
PS-330	E	3	4.125	3-1/4	BCFJF			HYD1Q8
FEDERAL PUMP								
PS-293	A	14	.815	5/8	BMFKF		Seat is Metal to Metal Press Fit	
PS-245	C	1	1.625	1	BCFJF	B/H		
PS-248	C	1	1.625	1	BCFKF	B/H		
PS-380	D	1	1.625	1	BCFJF			
PS-246	C	1	1.875	1-1/4	BCFJF	B/H		
PS-249	C	1	1.875	1-1/4	BCFKF	B/H		
PS-381	D	1	1.875	1-1/4	BCFJF			
PS-547	C	3	2.000	1-3/8	BCFKF			
PS-247	C	1	2.156	1-1/2	BCFKF	B/H		
PS-682	C	1	2.156	1-1/2	BCFJF	B/H		
PS-382	D	1	2.125	1-1/2	BCFJF			
PS-446	C	1	2.500	1-3/4	BCFJF			
PS-205	E	1	2.500	1-3/4	BCFJF			
FINN CORPORATION								
PS-185	C	1	1.875	1-1/4	BCFJF			80485
FLINT AND WALLING (Subsidiary of ZOELLER CO.)								
PS-165	B	9		1/2	BMFJF	A		132891/92
PS-800	C	1	1.156	5/8	BCFJF		Models:CA, C,BPA	AC-16,131100 132377
PS-201	A	1	1.375	3/4	BMFJF		81, 82, 83, 605, 607, 609 Shallow Well, 64, 65, 66, 67, 68 Deep Well	126544, 126545
PS-687	C	1	1.500	7/8	BCFKF			121224
PS-357	C	1	1.625	1	BCFKF		Series C211	129868
PS-204	E	1	1.750	1-1/8	BCFJF		Series CE-40 7 HP	125056

NOTE: A. MOUNTS ON SHAFT
 B. TAPERED SPRING
 E. LOCK COLLAR SOLD SEPARATELY
 H. SPRING HOLDER NOT INCLUDED

WHEN SEAL IDENTIFICATION IS DOUBTFUL, SEND SAMPLE ALONG WITH APPLICATION INFORMATION AND ALL PUMP NAMEPLATE DATA.



PUMP MANUFACTURERS CROSS-REFERENCE

U.S.Seal Part No.	Head	Seat	Seat O.D.	Shaft Dia.	Material Code	Notes	Pump Nameplate Data	MFG. PART #
FLOWAY (Div. of WEIR SPECIALTY PUMPS)								
PS-252	D	3	1.625	1	BCFKF			542949-2010
PS-137	E	1	1.875	1-1/4	BCFKF			13-90-0650
PS-264	E	3	1.875	1-1/4	BCFKF			545305-1010 231-31-413
FLUID PACK								
PS-238	C	1	2.375	1-5/8	BCFJF			SJ-2126-C1-00
FOOTE BROTHERS								
PS-383	D	1	1.875	1-1/4	BCFKF			
PS-186	D	1	2.000	1-3/8	BCDKF			
PS-371	D	1	2.125	1-1/2	BCFKF			
PS-462	D	1	2.750	2	BCDKF			
FRANKLIN ELECTRIC								
PS-452	B	9		5/8	BMFJF	A		
PS-1021	B	9		5/8	BMFJF	A		292456101
PS-1072	C	1	1.812	1	BCFJF			155069101/102 155330101/102
FREDERICK PUMP & ENGINE								
PS-952	A	1	1.250	5/8	BCFJF			
PS-360	A	1	1.625	1	BCFJF			
PS-185	C	1	1.875	1-1/4	BCFJF			
PS-756V	C	3	1.875	1-1/4	VCFKF			80912
PS-1042	U	1	2.500	1-3/4	BCFJF			
FRICK CO.								
PS-492 -CMS	C	3	3.250	2-3/8	BCFKF		80BA2-47	P-81905
GG INDUSTRIES								
PS-200	A	1	1.250	5/8	BMFJF			P-M03885
PS-642	B	---	---	5/8	BMF-F			P-M03857
PS-1000	B	1	1.250	5/8	BMFJF			P-Seal 4/P-Seal 5 Mark III
GALION								
PS-157	C	---	---	3/4	BCF-F			
PS-397	C	---	---	1	BCF-F			
GARDNER DENVER								
PS-441	B	9		3/4	BMFKF	A		60BN-1
PS-373	C	1	1.375	3/4	BCFKF			60AY-10
PS-360	A	1	1.625	1	BCFJF			
PS-370	A	1	1.625	1	BMFKF			60BT-1
PS-357V	C	3	1.625	1	VCFKF			60DD799
PS-236	E	1	1.625	1	BCFKF			60AY-2,16 &18
PS-605	D	1	1.750	1-1/8	BCFKF			60BC-10
PS-384	E	1	1.750	1-1/8	BCFKF			60AY-11 &13
PS-383	D	1	1.875	1-1/4	BCFJF			60BC-3
PS-137	E	1	1.875	1-1/4	BCFKF			60AY-14
PS-186	D	1	2.000	1-3/8	BCDKF			60BC-14
PS-354	E	1	2.000	1-3/8	BCFJF			60AY-14
PS-371	D	1	2.125	1-1/2	BCFKF			60BC-1,6,7,11,18
PS-382	D	1	2.125	1-1/2	BCFJF			60BC-1,6,7,11,18
PS-374	E	1	2.125	1-1/2	BCFKF			60AY-21
PS-461	D	1	2.375	1-5/8	BCDKF			60BC-2,5
PS-436V	C	3	2.500	1-3/4	VCFKF			60DD-596
PS-593	D	3	2.625	1-7/8	BCDKF			60BC-9, 12
PS-513	E	1	2.625	1-7/8	BCFKF			60AY-20
PS-1676V	C	3	3.125	2-1/4	VCFKF			60DD-104
PS-351	E	1	3.125	2-1/4	BCDKF			60AY-15
PS-463	D	3	3.375	2-1/2	BCDKF			60BC-8

NOTE: A. MOUNTS ON SHAFT

WHEN SEAL IDENTIFICATION IS DOUBTFUL, SEND SAMPLE ALONG WITH APPLICATION INFORMATION AND ALL PUMP NAMEPLATE DATA.



PUMP MANUFACTURERS CROSS-REFERENCE

U.S.Seal Part No.	Head	Seat	Seat O.D.	Shaft Dia.	Material Code	Notes	Pump Nameplate Data	MFG. PART #
GARWOOD INDUSTRIES								
PS-303	D	1	1.500	7/8	BCDKF			206556
PS-227	D	1	1.750	1	BCFKF			
PS-210	C	1	2.000	1-3/8	BCFKF			2016264
PS-376	D	---	---	1-3/8	BCD-F			2039056
GEARMASTER								
PS-1043	C	1	1.000	1/2	BMFJF			A34-3970
GECO SALES								
PS-1000	B	1	1.250	5/8	BMFJF			
GENERAL MOTORS CORP. (GMC)								
PS-642	B	---	---	5/8	BMF-F			5121751
PS-933	C	---	---	5/8	BCF-F			5186571
PS-752	D	1		3/4	BCDKF			5186113
PS-192	C	3	2.125	1-1/2	NCFGP			
GENERAL PUMP								
PS-200	A	1	1.250	5/8	BMFJF			
PS-810	C	1	1.250	5/8	NCDJF	B	1-1/2 HP to 2 HP	
GEORGIA PACIFIC PUMP								
PS-200	A	1	1.250	5/8	BMFJF			
GILBERT BARKER (GILBARCO, INC.)								
PS-1000	B	1	1.250	5/8	BMFJF			K81159X
PS-756	C	1	1.875	1-1/4	BCFKF			K74050X
PS-461	D	1	2.375	1-5/8	BCDKF			K76638X
PS-514	D	1	2.375	1-5/8	BCDJF			K76638X
GOLD-MARC INDUSTRIES								
PS-163	B	1	1.000	1/2	BMFJF			
GORMAN RUPP								
PS-106	C	1	1.000	1/2	BCFKF			25271-801
PS-106V	C	1	1.000	1/2	VCFKF			25271-802
PS-150	B	---	---	1/2	BMF-F		Seat is Impeller	S-8243-4
PS-788	B	1	1.000	1/2	BMFKF			
PS-218	A	---	---	5/8	BCF-F			12873-002
PS-200	A	1	1.250	5/8	BMFJF			S-1531, S-756
PS-507	A	1	1.250	5/8	BMFKF			S-217
PS-882	B	---	---	5/8	BCF-F			8243-12
PS-118	C	1	1.187	5/8	BCFJF			S-809
PS-359	C	1	1.250	5/8	BCFJF			S-765
PS-633	C	1	1.250	5/8	BCFKF			25271-824
PS-1080	C	1	1.250	5/8	NCFKF			25270-113
PS-1045	C	3	1.250	5/8	VCFJF			25271-821
PS-795	S	8	1.187	5/8	NAPSP			GS-625
PS-851	A	1	1.375	3/4	BCFJF			S-1190
PS-601	B	1	1.375	3/4	BMFJF		Model: 83E-F13	26822-008
PS-112	C	1	1.375	3/4	BCFKF			S-1679
PS-358	C	1	1.375	3/4	BCFJF			S-936, S-1575
PS-358V-CMS	C	1	1.375	3/4	VCFJF			25271-850
PS-373V	C	1	1.375	3/4	VCFKF			25271-021
PS-564	C	---	---	3/4	BCF-F			S-32
PS-750	D	1	1.375	3/4	BCDJF		Model: 82T-A8	S-383
PS-752	D	1	1.375	3/4	BCDKF		Model: 82T-A8	S-33
PS-792	S	8	1.500	3/4	NAPSP			GS-750
PS-2027V	D	3	1.500	7/8	VCFKF			25271-159
PS-360	A	1	1.625	1	BCFJF			S-2147
PS-397	C	---	---	1	BCF-F			S-237
PS-235	C	1	1.625	1	BCFJF			S-1906, S-1832
PS-357	C	1	1.625	1	BCFKF			



PUMP MANUFACTURERS CROSS-REFERENCE

U.S.Seal Part No.	Head	Seat	Seat O.D.	Shaft Dia.	Material Code	Notes	Pump Nameplate Data	MFG. PART #
GORMAN RUPP (continued)								
PS-357V	C	3	1.625	1	VCFKF			25271-870
PS-499	C	3	1.625	1	BCFKF			25271-869
PS-380	D	1	1.625	1	BCFJF			S-298 S-1415
PS-460	D	1	1.625	1	BCFKF			S-363, S-364
PS-236	E	1	1.625	1	BCFKF			S-388
PS-557	E	3	1.625	1	BCFJF			25271-032
PS-793	S	8	1.750	1	NAPSP			GS-1000
PS-867	E	3	1.750	1-1/8	BCFKF	E		25271-039
PS-867V	E	3	1.750	1-1/8	VCFKF	E		25271-037
PS-756	C	1	1.875	1-1/4	BCFKF			S-1621
PS-756V	C	3	1.875	1-1/4	VCFKF			25271-836 25271-886
PS-185V	C	3	1.875	1-1/4	VCFJF			25271-888
PS-598	C	3	1.875	1-1/4	BCFKF			25271-889
PS-383	D	1	1.875	1-1/4	BCFKF			S-37, S-493
PS-381	D	1	1.875	1-1/4	BCFJF			S-321
PS-517	D	3	1.875	1-1/4	BCFKF			S-493-C
PS-981	D	3	1.875	1-1/4	VCFKF			S-321 A
PS-383V	D	3	1.875	1-1/4	VCFKF			25271-192
PS-137	E	1	1.875	1-1/4	BCFKF			S-350
PS-361	E	1	1.875	1-1/4	BCFJF			S-335
PS-546	E	3	1.875	1-1/4	BCFKF			42029
PS-794	S	8	2.125	1-1/4	NAPSP			GS-1250
PS-2234	E	3	2.062	1-7/16	BCFKF			25271-051
PS-334V	E	2	2.062	1-7/16	VCFKF			25271-056
PS-659V	C	3	2.125	1-1/2	VCFKF			25271-903
PS-758	C	1	2.125	1-1/2	BCFJF			S-1150
PS-371	D	1	2.125	1-1/2	BCFKF			S-283, S-317, S-774
PS-534	D	3	2.125	1-1/2	BCFKF	H		S-1934
PS-371V	D	3	2.125	1-1/2	VCFKF			25271-207
PS-7079	D	28	2.375	1-1/2	VZFFZ			12364A
PS-374	E	1	2.125	1-1/2	BCFKF	H		S-239
PS-239V	C	3	2.375	1-5/8	VCFKF			25271-921
PS-544	C	3	2.375	1-5/8	BCFKF			25271-922
PS-2058	E	1	2.375	1-5/8	BCFKF			25271-061
PS-1683	E	3	2.375	1-5/8	BCFJF			25271-064
PS-446	C	1	2.500	1-3/4	BCFJF			S-1822
PS-446V	C	1	2.500	1-3/4	VCFJF			25271-942
-CMS								
PS-436	C	3	2.500	1-3/4	BCFKF			25271-947, 25271-943
PS-1145	C	3	2.750	2	VCFKF			25271-983
PS-267V	C	3	2.750	2	VCFJF			25276-661
-CMS								
PS-1688	E	3	3.125	2-1/4	BCFJF			25271-095
PS-463	D	3	3.375	2-1/2	BCDKF			25271-291
GOULDS PUMPS (Div. of ITT INDUSTRIES)								
PS-631	C	1	1.000	1/2	BCFJF			
PS-1002	C	1	1.000	1/2	BCFJF		Fig . 3604	74207-0050
PS-1002V	C	1	1.000	1/2	VCFJF			74208-0050 74209-0050
PS-518	A	1	1.187	5/8	BCFKF			10K6
PS-701	A	1	1.187	5/8	BMFKF		Balanced Flow BF-03, Figs.: 3648, 3628, 3728, 3748, 3642, 3742, 3638, 3738, 3788, and 3811	10K2, 72598-3062
PS-702	A	1	1.187	5/8	BMFJF		Balanced Flow BF-03, Series: LS, LD, G, O, M, XS05,15, 20, 30, 50, Jetomatic, Fig. 3642, 3742, Fig 3672	10K1 70470-5062 72598-1062, 20-83-1100

WHEN SEAL IDENTIFICATION IS DOUBTFUL, SEND SAMPLE ALONG WITH APPLICATION INFORMATION AND ALL PUMP NAMEPLATE DATA.

NOTE: E. LOCK COLLAR SOLD SEPARATELY
H. SPRING HOLDER NOT INCLUDED



PUMP MANUFACTURERS CROSS-REFERENCE

U.S.Seal Part No.	Head	Seat	Seat O.D.	Shaft Dia.	Material Code	Notes	Pump Nameplate Data	MFG. PART #
GOULDS PUMPS (Div. of ITT INDUSTRIES) (continued)								
PS-702V	A	1	1.187	5/8	VMFJF			10K24
PS-957	A	1	1.187	5/8	BCFJF			10K10
PS-600	B	1	1.187	5/8	BMFJF		Fig. 3231	
PS-700	B	1	1.187	5/8	BMFJF		Cellar Drainer Fig. 3631	10K7
PS-1000V	B	3	1.250	5/8	VCFJF			696-0442
PS-493	C	1	1.187	5/8	BCFKF		Fig. 3377 and 3371 Multi Stage	10K3
PS-1155	C	1	1.187	5/8	BCFJF			10K46
PS-1155V	C	1	1.187	5/8	VCFZF			10K-55
PS-2214	C	1	1.187	5/8	QCFJF			10K18, 10K-18
PS-750	D	1	1.375	3/4	BCDJF		Multi Stage Dapto Flo Series R	10K4
PS-303	D	1	1.500	7/8	BCDKF			70470-4087
PS-703	D	1	1.500	7/8	BCDJF		XS15,20,50 Aqua Lawn Jetomatic, Fig. 3629, 3649, 3729,3749, 3639, 3739, 3678 and 3789	10K8
PS-235	C	1	1.625	1	BCFJF			84001-2
PS-236	E	1	1.625	1	BCFKF			69127-2100
PS-557	E	3	1.625	1	BCFJF			91666-1000 91670-1000
PS-754	E	1	1.625	1	BCFJF		Fig. 3169M, 3750S, 3655, 3450, 3650, 3750 & 3755	70783-1100
PS-710	E	1	1.750	1-1/16	BCFJF		Fig. 3405, 3305S	70783-3106
PS-588	C	3	1.750	1-1/8	BCFKF	B	Fig. 3643	76407-1112,10K9
PS-356	C	1	1.750	1-1/8	BCFJF		Fig. 3643	10K21
PS-185	C	1	1.875	1-1/4	BCFJF		Fig. 3656	10K13, 9152071001
PS-185V -CMS	C	1	1.875	1-1/4	VCFJF			10K25
PS-185V	C	3	1.875	1-1/4	VCFJF			10K19
PS-510	D	1	2.000	1-1/4	BCFJF			51010
PS-361	E	1	1.875	1-1/4	BCFJF		2" Fig. 3460	
PS-2128	E	3	1.875	1-1/4	BCFJF		3316-3405 Group S	
PS-2129	E	3	1.875	1-1/4	BCFKF		3316-3405 Group S	
PS-177	C	1	2.000	1-3/8	BCFJF			52-115-605-801
PS-354	E	1	2.000	1-3/8	BCFJF		Fig. 3345, 3320	
PS-677	E	1	2.000	1-3/8	BCFKF			
PS-864	E	3	2.000	1-3/8	BCFJF		3196ST	
PS-865	E	3	2.000	1-3/8	BCFKF		3196ST	
PS-705	E	3	2.062	1-7/16	BCFJF		Fig. 3405M, 3305M	70783-3143
PS-305	E	1	2.125	1-1/2	BCFJF		Fig. 3169, 3650, 3655,3750 For Group M and K, 2-1/2" Fig. 3430	70783-1150
PS-374	E	1	2.125	1-1/2	BCFKF			
PS-395	E	3	2.125	1-1/2	BCFJF			776A908-2
PS-238	C	1	2.375	1-5/8	BCFJF		3656M	10K16
PS-238V -CMS	C	1	2.375	1-5/8	VCFJF			10K26
PS-238V	C	3	2.375	1-5/8	VCFJF			46984000000
PS-818	C	3	2.375	1-5/8	BCFJF			45162000000
PS-239 -EPR	C	3	2.375	1-5/8	QCFKF			10K20
PS-397V	C	3	1.625	1	VCFKF			41355000000
PS-446	C	1	2.500	1-3/4	BCFJF			9152091001
PS-535	E	3	2.500	1-3/4	BCFJF		3196MT - 3735/36M	
PS-262	E	3	2.500	1-3/4	BCFKF			
PS-1078	E	27	3.000	1-3/4	BCFJF		3316-3405M	
PS-1684	E	3	2.312	1-3/4	BCFJF		3316, 3405 Group M	
PS-707	E	3	2.875	2-1/16	BCDKF		Fig. 3305, 3405, 3306, 3406 Group L	
PS-1679	C	1	3.125	2-1/4	BCFJF			9152111001
PS-849	E	3	3.125	2-1/4	BCDKF			



PUMP MANUFACTURERS CROSS-REFERENCE

U.S.Seal Part No.	Head	Seat	Seat O.D.	Shaft Dia.	Material Code	Notes	Pump Nameplate Data	MFG. PART #
GRAHAM ENGINEERING								
PS-1688	E	3	3.125	2-1/4	BCFJF			65100021
GRAINGER (See TEEL PUMP)								
GRISWOLD								
PS-758	C	1	2.125	5/8	BCFKF			
PS-2142	C	1	2.500	1-3/4	BCFJF			10037000
GUSHER PUMPS								
PS-164	B	9	.906	1/2	BMFKF	A	5pxl 630-262	5006-5005
PS-165	B	9	.906	1/2	BMDJF			84084
PS-1043	C	1	1.000	1/2	BMFJF			84083
PS-701V	A	1	1.187	5/8	VCFKF			84090
PS-957	A	1	1.187	5/8	BCFJF			84081
PS-359V -TC-SEAT	C	1	1.250	5/8	VCFZF			84000-24
PS-1079	C	1	1.250	5/8	NCFJF			
PS-1080	C	1	1.250	5/8	NCFKF			
PS-2160	C	1	1.250	5/8	BCFJF			84000-2
PS-441	B	9	---	3/4	BMFKF			84082
PS-309	C	1	1.500	7/8	BCFJF			84079-2
PS-2024	D	1	1.500	7/8	BCFJF			84138-1
PS-235	C	1	1.625	1	BCFJF			84001-2 84001-12
PS-1081	C	1	1.875	1-1/4	NCFJF			
PS-1082	C	1	1.875	1-1/4	NCFKF			
PS-1083	C	1	1.875	1-1/4	NCFJF			
PS-1084	C	1	1.875	1-1/4	NCFKF			
PS-2122	C	1	1.875	1-1/4	BCFJF		11019CIHA	84002-31
PS-2122V	C	1	1.875	1-1/4	VCFJF			
PS-2215	C	1	1.875	1-1/4	QCFJF			84002-18
PS-2107	C	---	---	1-5/8	BCF-F			84004-55
PS-239	C	1	2.375	1-5/8	BCFKF			84004-18
PS-239V -CMS	C	1	2.375	1-5/8	VCFKF			84004-7
PS-238	C	1	2.375	1-5/8	BCFJF			84004-28
PS-3664	C	1	2.375	1-5/8	BZFZF			84004-30
H & F MFG., CO.								
PS-1000	B	1	1.250	5/8	BMFJF			
HAIGHT PUMP								
PS-825	D	3	2.500	1-3/4	BCDKF			AP13.518X
PS-237V	D	3	2.500	1-3/4	VCDKF			AP13.518Y
HALE PRODUCTS								
PS-201	A	1	1.375	3/4	BMFJF			292-5040-00-3
PS-851	A	1	1.375	3/4	BCFJF			296-5040-00
PS-360	A	1	1.625	1	BCFJF			296-5010-00
PS-235	C	1	1.625	1	BCFJF			25D-G444
							Model 20FD 106434	1001-02-20-00
PS-1048	C	1	1.625	1	BCFJF	H		296-5060-00-3
PS-548	C	3	1.625	1	BCFJF			296-5060-06-0
PS-1049	C	3	1.625	1	BCFJF	H		296-5050-000
PS-356	C	1	1.750	1-1/8	BCFJF			296-5220-00
PS-177	C	1	2.000	1-3/8	BCFJF			296-5250-99
PS-495	K	1	2.000	1-3/8	BCFJF			296-5070-00
PS-347	C	1	2.125	1-1/2	BCFJF	B/H		6D-58
PS-378	C	1	2.125	1-1/2	BCFKF	B/H		296-5020-06
PS-659	C	1	2.125	1-1/2	BCFKF			296-5021-01
PS-758	C	1	2.125	1-1/2	BCFJF	H		296-5021-03
PS-2209	C	1	2.125	1-1/2	BZFZF			296-5021-06-0
PS-267	C	1	2.750	2	BCFJF			296-5210-00

WHEN SEAL IDENTIFICATION IS DOUBTFUL, SEND SAMPLE ALONG WITH APPLICATION INFORMATION AND ALL PUMP NAMEPLATE DATA.

NOTE: A. MOUNTS ON SHAFT
 B. TAPERED SPRING
 H. SPRING HOLDER NOT INCLUDED



PUMP MANUFACTURERS CROSS-REFERENCE

U.S.Seal Part No.	Head	Seat	Seat O.D.	Shaft Dia.	Material Code	Notes	Pump Nameplate Data	MFG. PART #
HALL SCOTT								
PS-200	A	1	1.250	5/8	BMFJF			
PS-750	D	1	1.375	3/4	BCDJF		Pump 390	
HARVEY SID, INC.								
PS-1050	C	---	---	1/2	BCF-F			
HAYWARD								
PS-200	A	1	1.250	5/8	BMFJF		Cast Iron	SPX-1250X-Z-2
PS-2131	A	Spec.		5/8	BMFJ/MF	G	Power-Flo®, Power-Flo-II®, Turbo Flo®	SPX-1500-KA
PS-201	A	1	1.375	3/4	BMFJF		Max-Flo®, Super Pump®, Super Pump II®	SPX-1600-Z-2
PS-370	A	1	1.625	1	BMFKF			
HEINECKE								
PS-101	A	1	1.437	3/4	BMFJF		Model 2T	
HOBERT MFG.								
PS-631	C	1	1.000	1/2	BCFJF			R-23682
PS-663	Q	1	1.000	1/2	BMFJF			C115710
PS-1085	C	1	1.250	5/8	V/BCFJF			A104329 114696
PS-235	C	1	1.625	1	BCFJF			R-79205
PS-539	C	1	1.625	1	BCFJF	H		R-87809
PS-754	E	1	1.625	1	BCFJF			
PS-754V	E	3	1.625	1	BCFJF			A104330
PS-758	C	1	2.125	1-1/2	BCFJF			
HOMART-SEARS								
PS-162	A	1	1.000	1/2	BMFJF			259-043, W6476
PS-100	A	1	1.187	5/8	BMFJF			42G2377W
PS-508	D	1	1.250	5/8	BCDJF			759-31
HOMELITE								
PS-200	A	1	1.250	5/8	BMFJF			62729
PS-711	A	3	1.187	5/8	BMFJF			A-62861-2
PS-201	A	1	1.375	3/4	BMFJF			A75911
PS-601	B	1	1.375	3/4	BMFJF			43271
PS-360	A	1	1.625	1	BMDJF			A62403
PS-1086	A	3	2.000	1	BCFJF			A62713, A62713-1
PS-1086V	A	3	2.000	1	VCFJF			62713-2
PS-235	C	1	1.625	1	BCFJF			47046
PS-466	C	1	2.000	1-1/4	BCFJF			46150
HYDROMATIC PUMP CO. (Div. of PENTAIR)								
PS-1621	Q	9		1/2	BMFJF	A		05484-000-1
PS-218	A	---	---	5/8	BCF-F			00083-007-1
PS-299	A	-	-	5/8	BMF-F			00083-002-1
PS-200	A	1	1.250	5/8	BMFJF			83
PS-200V -CMS	A	1	1.250	5/8	VCFJF			00083-010-1
PS-447	B	9		5/8	BCFJF	A		07548-000-1
PS-201	A	1	1.375	3/4	BMFJF			17048-0-1
PS-1622	B	9		3/4	BMFJF	A		4917/8
PS-358	C	1	1.375	3/4	BCFJF			00100-000-1
PS-750	D	1	1.375	3/4	BCDJF			100
PS-235	C	1	1.625	1	BCFJF			00300-000-1
PS-235V -CMS	C	1	1.625	1	VCFJF			00300-001-1
PS-2216	C	1	1.625	1	BZFFZ			00696-000-1
PS-185	C	1	1.875	1-1/4	BCFJF			04916-000-1
PS-185V -CMS	C	1	1.875	1-1/4	VCFJF			04916-002-1
PS-2209	C	1	2.125	1-1/2	BZFFZ			00920-004-4

NOTE: A. MOUNTS ON SHAFT
 G. MOUNTS IN PLASTIC
 H. SPRING HOLDER NOT INCLUDED

WHEN SEAL IDENTIFICATION IS DOUBTFUL, SEND SAMPLE ALONG WITH APPLICATION INFORMATION AND ALL PUMP NAMEPLATE DATA.



PUMP MANUFACTURERS CROSS-REFERENCE

U.S.Seal Part No.	Head	Seat	Seat O.D.	Shaft Dia.	Material Code	Notes	Pump Nameplate Data	MFG. PART #
HYDROMATIC PUMP CO. (Div. of PENTAIR) (continued)								
PS-758	C	1	2.125	1-1/2	BCFJF			00920-001-1
PS-7509	C	1	2.125	1-1/2	VCFJF			00920-003-1/00920-007-1
PS-446	C	1	2.500	1-3/4	BCFJF			11049-001-1
PS-340	C	1	2.625	1-7/8	BCFJF			14859-000-1
PS-267	C	1	2.750	2	BCFJF			01957-000-1
PS-267V -CMS	C	3	2.750	2	VCFJF			01957-001-1
PS-2219	C	1	2.750	2	BZFZF			01957-002-1
PS-1087	C	1	3.125	2-1/4	BCFJF			08073-000-1
PS-7064	C	1	3.125	2-1/4	BZFZF			8073-001-1
PS-1088	C	3	3.875	3	BCFJF	B		03718-000-1
HYPRO CORPORATION								
PS-200V	A	3	1.250	5/8	VCFJF			9501-4, 9202-C
PS-200V -CMS	A	1	1.250	5/8	VCFJF			2120-0009
PS-516	A	1	1.250	5/8	BCFJF			9501-3, 2120-0008
PS-359V	C	3	1.250	5/8	VCFJF			2120-3
PS-201V	A	3	1.375	3/4	VCFJF			9501-50
PS-235	C	1	1.625	1	BCFJF			21399
IMO (See DELAVAL)								
INGERSOLL RAND (Div. of FLOWERVE CORP.)								
PS-164	B	9		1/2	BMFKF	A		
PS-200	A	1	1.250	5/8	BMFJF			CPM-6252C1
PS-507V	A	3	1.250	5/8	VCFKF			CPM-6258C1
								CPM-625271
PS-600	B	1	1.187	5/8	BMFJF		Bronze Fitted KRVS-3/4, 1-1/4, Model B 1/4 to 1-1/2 HP Motors	CPM-625871
								CPM-10015
PS-616	B	1	1.187	5/8	BMFKF		Iron Fitted KRVS-3/4, 1-1/4, Model B 1/4 to 1-1/2 HP Motors	CPM-10029
PS-359	C	1	1.250	5/8	BCFJF		1x 4, -3/4, 1, 1-1/4, 2 x 5 HK & HOK	CPM-6251C1
PS-633	C	1	1.250	5/8	BCFKF		1x 4, 3/4, 1, 1-1/4, 1-1/2, 2 x 5 HK,	CPM-625171
PS-760	A	3	1.375	3/4	BMFJF		SMP 1000 & SMP 2000	CPM-10600A
PS-601	B	1	1.375	3/4	BMFJF		All Bronze Fitted Pump	CPM-10034
PS-606	B	1	1.375	3/4	BMFKF			CPM-10035
PS-564	C	---	---	3/4	BCF-F			024439-00
PS-3654	C	1	1.375	3/4	BCFKF			SMP2000
PS-2236	C	3	1.375	3/4	BCFJF			1802ATY21ORM075BF1C1 607217-92
PS-303	D	1	1.500	7/8	BCDKF			W-11448, W-20168
PS-602	D	1	1.562	7/8	BCDJF		KRVS-1-1/2, 2, 3 1/4 to 1-1/2 HP	CPM-10052
PS-603	D	2	1.562	7/8	BCDKF			CPM-10053
PS-2226	C	3	1.750	1-1/8	QCFZF	I	3 x 5 HK, 3 x 6 HK, HOK	CPM-112171
PS-801	C	3	1.750	1-1/8	BCFJF		3 x 5 HK, 3 x 6 HK & HOK	CPM-1121C1
PS-604	D	1	1.750	1-1/8	BCFJF		Bronze Fitted KRVS-1, 1-1/2, 2, 3 2 to 25 HP Motors	CPM-10054
								CPM-10026
PS-605	D	1	1.750	1-1/8	BCFKF		Iron Fitted KRVS-1, 1-1/2, 2, 3 2 to 25 HP Motors	CPM-10055
PS-521	D	2	1.875	1-1/8	BCDKF			W-31826
PS-607	E	1	1.687	1-1/8	BCFJF		Bronze Fitted 1, 2 RVN-1 1-1/2, 2, 3 RVNL, 1-1/2, 2 RV and RVH-3RVS, 1-1/2 RVL, .	CPM-10043
PS-608	E	1	1.687	1-1/8	B/VCFKF		Iron Fitted 1, 2 RVN-1 1-1/2, 2, 3 RVNL, 1-1/2, 2 RV and RVH-3RVS, 1-1/2 RVL,	CPM-10044
								CPM-10087
PS-204V	E	3	1.750	1-1/8	VCFJF			CPM 10715A
PS-867	E	3	1.750	1-1/8	BCFKF			CPN-68885865
PS-619	E	3	1.812	1-1/8	BCFJF		Long Nose Carbon	CPM-10217A
								CPM 10220A

WHEN SEAL IDENTIFICATION IS DOUBTFUL, SEND SAMPLE ALONG WITH APPLICATION INFORMATION AND ALL PUMP NAMEPLATE DATA.

NOTE: A. MOUNTS ON SHAFT
 B. TAPERED SPRING
 I. ABRASION RESISTANT CARBON (P66)



PUMP MANUFACTURERS CROSS-REFERENCE

U.S. Seal Part No.	Head	Seat	Seat O.D.	Shaft Dia.	Material Code	Notes	Pump Nameplate Data	MFG. PART #
INGERSOLL RAND (Div. of FLOWSERVE CORP.) (continued)								
PS-948	E	3	1.812	1-1/8	BCPKF		Long Nose Carbon	CPM-10220B CPM-10217B
PS-1172V	E	3	1.812	1-1/8	VCFJF			CPM-10406A
PS-1636	E	3	1.812	1-1/8	B/VCFJF		H/HC/VOC/HOC	CPM-10465A
PS-1637	E	3	1.812	1-1/8	B/VCFKF		H/HC/VOC/HOC	CPM-10465B CPM-10470B
PS-1639V	E	3	1.812	1-1/8	VCFKF			CPM-10406B
PS-1668	E	3	1.812	1-1/8	BCFZF			CPM-10465C
PS-343	E	1	1.875	1-3/16	BCDKF			CPM-118S429X2
PS-310	E	1	1.875	1-3/16	BCDJF			CPM-118S429X5
PS-723	T	1	1.875	1-3/16	BCDJF		Models DMV and DHV	CPM-118S429X4
PS-724	T	1	1.875	1-3/16	BCDKF		Models DMV and DHV	CPM-118S429X3
PS-185V	C	3	1.875	1-1/4	VCFJF			CPM-10613A
PS-598 -EPR	C	3	1.875	1-1/4	QCFKF			CPM-10604A
PS-618	C	3	1.875	1-1/4	BCFJF		SMP 3000 & SMP 2000	1802ATY21ORM125BF1C1 60721800 / 609809-19 CPM-10601A
PS-756V	C	3	1.875	1-1/4	VCFKF			748988-00
PS-2203	C	3	1.875	1-1/4	QCFKF			CPM-68867910 1802ATY21ORM125O28F171
PS-416	D	---	---	1-1/4	BCF-F	H		748988-00
PS-467	C	1	2.125	1-3/8	BCFKF			W-28861, W-21642
PS-354	E	1	2.000	1-3/8	BCFJF			CPM-137S429X5
PS-677	E	1	2.000	1-3/8	BCFKF			CPM-137S429X2
PS-725	T	1	2.000	1-3/8	BCFJF			CPM-137S429X4
PS-726	T	1	2.000	1-3/8	BCFKF			CPM-137S429X3
PS-371	D	1	2.125	1-1/2	BCFKF			W-27658
PS-224	E	3	2.125	1-1/2	NCFKF			CPM-10129
PS-620	E	3	2.312	1-1/2	BCFJF		Long Nose Carbon	CPM-10218A CPM-10221A
PS-1190	E	1	2.125	1-1/2	BCFJF		GTB	CPM-10367A CPM-10368A
PS-258	E	3	2.125	1-1/2	BCFKF		GTB	CPM-10367B CPM-10368B
PS-305V	E	3	2.125	1-1/2	VCFKF		GTB	CPM-10369A 1802AJCTYP1A150XF1C1
PS-374V	E	3	2.125	1-1/2	VCFKF		GTB	CPM-10369B 1802AJCTYP1A150XF171
PS-1647	E	3	2.312	1-1/2	B/VCFJF		H/HC	CPM-10466A CPM-10471A
PS-1648	E	3	2.312	1-1/2	B/VCFKF		H/HC	CPM-10466B CPM-10471B
PS-1651	E	3	2.312	1-1/2	VCFJF		H/HC	CPM-10473A
PS-1652	E	3	2.312	1-1/2	VCFKF		H/HC	CPM-10473B
PS-1690	E	3	2.312	1-1/2	VCFJF		Long Nose Carbon	CPM-10224A 60514122
PS-1691	E	3	2.312	1-1/2	VCFKF		Long Nose Carbon	CPM-10224B CPM-10218B CPM-10221B
PS-1692	E	3	2.312	1-1/2	VCFZF		Long Nose Carbon	CPM-10224C
PS-818	C	3	2.375	1-5/8	BCFJF		SMP 3000	CPM-10602A, 607218-18
PS-346	E	1	2.312	1-5/8	BCPJF		3 RVL	CPM-10028
PS-484	E	1	2.312	1-5/8	BCDKF			X33548P1
PS-609	E	1	2.312	1-5/8	BCDJF		2,3,4 and 5RVL-3 RVH-1-1/2 0RVL	CPM-10045
PS-610	E	1	2.312	1-5/8	BCPKF		2,3,4 and 5RVL-3 RVH-1-1/2 0RVL	CPM-10046
PS-366	E	1	2.500	1-3/4	BCFKF		S-Line Series 100	CPM-10347
PS-674	T	1	2.500	1-3/4	BCFJF		3, 4, 5 RVL and CRVL	CPM-10024

NOTE: H. SPRING HOLDER NOT INCLUDED

WHEN SEAL IDENTIFICATION IS DOUBTFUL, SEND SAMPLE ALONG WITH APPLICATION INFORMATION AND ALL PUMP NAMEPLATE DATA.



PUMP MANUFACTURERS CROSS-REFERENCE

U.S.Seal Part No.	Head	Seat	Seat O.D.	Shaft Dia.	Material Code	Notes	Pump Nameplate Data	MFG. PART #
INGERSOLL RAND (Div. of FLOWERVE CORP.) (continued)								
PS-719	E	1	2.625	1.771	BCFKF			CPM-177S429X2
PS-722	E	1	2.625	1.771	BCFJF			CPM-177S429X5
PS-727	T	1	2.625	1.771	BCFJF			CPM-177S429X4
PS-728	T	1	2.625	1.771	BCFKF			CPM-177S429X3
PS-340 -EPR	C	1	2.625	1-7/8	QCFJF			CPM-10656
PS-513V	E	3	2.625	1-7/8	VCFKF			6885961
PS-586	E	3	2.625	1-7/8	BCFKF		3GT	CPM-10158A/CPM-10370B
PS-1654	E	3	2.625	1-7/8	BCFJF		GTB	CPM-10370A
PS-1656	E	3	2.625	1-7/8	BCPJF		GTB	CPM-10371A
PS-1657	E	3	2.625	1-7/8	BCPKF		GTB	CPM-10371B
PS-1659	E	3	2.625	1-7/8	VCFJF		GTB	CPM-10372A
PS-1660	E	3	2.625	1-7/8	VCFKF		GTB	CPM-10372B
PS-1661	E	3	2.625	1-7/8	VCFZF			CPM-10716C 1802AJCTYP1A188-XF1D1
PS-829	E	3	2.687	1-7/8	BCFJF		Long Nose Carbon	CPM-10219A/CPM-10461A
PS-831	E	3	2.687	1-7/8	BCFKF		Long Nose Carbon	CPM-10219B
PS-946	E	3	2.687	1-7/8	BCPJF		Long Nose Carbon	CPM-10222A
PS-949	E	3	2.687	1-7/8	BCPKF		Long Nose Carbon	CPM-10222B
PS-1662	E	3	2.687	1-7/8	B/VCFJF		VOC/HOC	CPM-10467A
PS-1663	E	3	2.687	1-7/8	B/VCFKF		VOC/HOC	CPM-10467B
PS-1664	E	3	2.687	1-7/8	B/VCPJF		H/HC/VOC/HOC	CPM-10472A
PS-1665	E	3	2.687	1-7/8	B/VCPKF		H/HC/VOC/HOC	CPM-10472B
PS-7020	E	3	2.687	1-7/8	VCFJF			CPM-10225A CPM-10408A
PS-1653	T	3	2.687	1-7/8	VCFJF		HOC 6 x 4 x 13	CPM-10278
PS-342	E	3	2.750	2	NCPKP		1-1/2,2 and 3 VM-1-1/2 and 3 VL 3 VLA Vertical Pumps and S Line	CPM-10130 CPM-200S429X1
PS-477	E	3	2.750	2	BCFKF		S Line Item 206	CPM-200S429X2 CPM-200S429X7
PS-530	E	3	2.750	2	BCFJF			
PS-611	E	3	2.812	2-1/8	BCFJF		All Bronze Fitted Pump 1-1/2,2 MRV-5 RVH,6 RVL, 50RVL D	CPM-10047
PS-1612	E	3	2.812	2-1/8	BCFKF		All Iron Fitted Pumps 1-1/2,2 MRV-5 RVH,6 RVL, 50RVL D	CPM-10048
PS-2086	E	3	3.000	2-1/8	BCFKF		Series 100S	CPM-10351
PS-350	E	3	3.250	2-3/8	BCFKF		4GT/S/HOC	CPM-10159/CPM-10469B
PS-278	E	3	3.250	2-3/8	BCFJF		HOC	CPM-10469A
PS-2098V	E	3	3.250	2-3/8	VCFKF			CPM-10718B
PS-279	E	3	3.375	2-1/2	BCFJF			CPM-10134
PS-349	E	3	3.375	2-1/2	BCFKF		S Line Item 208	CPM-250S429X2 CPM-250S429X7
PS-321	E	3	3.500	2-3/4	BCFKF		S Line Series 100	CPM-10355
PS-475	E	3	3.875	3	BCDKF		6GT	
PS-325	U	3	4.125	3-1/4	BCFKF		S Line 211, 8 x 14SD,10 x 14SD	CPM-325S429X2
INSINGER								
PS-204	E	1	1.750	1-1/8	BCFJF			B15
ITT (See ALLIS CHALMERS, BELL & GOSSETT, DOMESTIC PUMP, JABSCO, MARLOW)								
JABSCO (Div. of ITT INDUSTRIES)								
PS-642	B	---	---	5/8	BMF-F		Seat is Impeller	1/2" Motor Pump
PS-382	D	1	2.125	1-1/2	BCFJF			3200 and 3200-01 3200-21
JACKSON PRODUCTS								
PS-1089	B	1	1.093	5/8	V/BCFJF			5330-300-09-27
PS-309V	C	3	1.500	7/8	VCFJF			5330-300-06-27



PUMP MANUFACTURERS CROSS-REFERENCE

U.S.Seal Part No.	Head	Seat	Seat O.D.	Shaft Dia.	Material Code	Notes	Pump Nameplate Data	MFG. PART #
JACUZZI (Div. of STA-RITE INDUSTRIES)								
PS-162	A	1	1.000	1/2	BMFJF		Vector (LVL)	10-563
PS-631	C	1	1.000	1/2	BCFJF		Model 5AM	10-564
PS-200	A	1	1.250	5/8	BMFJF		Cygnat K,KM A, J, JCM, LCM, LCU and LR Series	10-467, 10-1436-00 10-0002-06
PS-516	A	1	1.250	5/8	BCFJF			10-1436-00
PS-290	C	1	1.250	5/8	BCFJF			10-1202, 10-1203
PS-359	C	1	1.250	5/8	BCFJF			10-478, 10-506
PS-102	D	1	1.250	5/8	BCDKF			10-502
PS-201	A	1	1.375	3/4	BMFJF		Model 5RP, SF, Magnum, RC-Series	10-477,10-486, 10-120, 10-1390-04,10-1502-09
PS-358	C	1	1.375	3/4	BCFJF			10-479
PS-683	C	1	1.500	3/4	BCFJF			10-100
PS-877	C	1	1.375	3/4	BCFJF			10-1203-19
							8M	10-1203-01
PS-750	D	1	1.375	3/4	BCDJF			10-503
PS-235	C	1	1.625	1	BCFJF		10M	10-504, 10-1299-06
PS-204	E	1	1.750	1-1/8	BCFJF			10-505
PS-185	C	1	1.875	1-1/4	BCFJF			10-0369-29, 10-1400-02
PS-2122	C	1	1.875	1-1/4	BCFJF			10-0369-03
PS-209	K	---	---	1-3/8	BCF-F			10-315, 10-328
PS-758	C	1	2.125	1-1/2	BCFJF			10-1348-07
PS-2142	C	1	2.500	1-3/4	BCFJF			10-0307-00
PS-205	E	1	2.500	1-3/4	BCFJF			10-330
PS-213	R	---	---	1-3/4	BCD-F			10-323
PS-874	D	1	3.125	2-1/4	BCDJF			10-365
JAEGER								
PS-201	A	1	1.375	3/4	BMFJF			
PS-360	A	1	1.625	1	BCFJF			
PS-356	C	1	1.750	1-1/8	BCFJF			80237
PS-177	C	1	2.000	1-3/8	BCFJF			81031-1
PS-461	D	1	2.375	1-5/8	BCDKF			66319-1
PS-876	D	1	2.625	2	BCDKF			66435-1
JOY MFG. (See SULLIVAN PALATEK)								
KADY INTERNATIONAL								
PS-687	C	1	1.500	7/8	BCFKF			91381
PS-210	C	1	2.000	1-3/8	BCFKF			91379
KELIN PRODUCTS								
PS-154	C	---	---	1-1/4	BCF-F			33011197
PS-547	C	3	2.000	1-3/8	BCFKF			33039175
KENCO								
PS-162	A	1	1.000	1/2	BMFJF		Type 62,63,64,65	
PS-163	B	1	1.000	1/2	BMFJF			AE001A1
PS-165	B	9		1/2	BMFJF	A	59A,140A	
PS-200	A	1	1.250	5/8	BMFJF		Model 139A New Style	
PS-452	B	9		5/8	BMFJF	A	Model 109A New Style	
PS-762	A	3	1.375	3/4	BMFKF		Model 114	6A001A1
KINNEY VACUUM PUMP (Div. of TUTHILL VACUUM SYSTEMS)								
PS-358	C	1	1.375	3/4	BCFJF			KC2.5-15, KS-13 KC-5, KC-8(491)
PS-358V	C	3	1.375	3/4	VCFJF			65046
PS-197	K	---	---	7/8	BCF-F			SK-549
PS-357	C	1	1.625	1	BCFKF			KS-27-47
PS-159	D	3	1.625	1	NCPGP		KS-27-47, VSM-778-8811	65024
PS-355	C	1	1.750	1-1/8	BCFKF			KC-46
PS-177V	C	3	2.000	1-3/8	VCFJF			065046-A-000
PS-659	C	1	2.125	1-1/2	BCFKF			KD-110, KDH-130



PUMP MANUFACTURERS CROSS-REFERENCE

U.S.Seal Part No.	Head	Seat	Seat O.D.	Shaft Dia.	Material Code	Notes	Pump Nameplate Data	MFG. PART #
KINNEY VACUUM PUMP (Div. of TUTHILL VACUUM SYSTEMS) (continued)								
PS-238V -CMS	C	1	2.375	1-5/8	VCFJF			065241-A000
PS-366	E	1	2.500	1-3/4	BCFKF			KD-220, KDH-220
PS-462	D	1	2.750	2	BCDKF			
PS-658	R	1	2.750	2	BCDKF			KBM-1200, MB-17
KRAISSL COMPANY								
PS-150	B	---	---	1/2	BMF-F		Seat is Impeller	
KRUM PUMP								
PS-516	A	1	1.250	5/8	BCFJF			1181377
LANCASTER PUMP CO.								
PS-150	B	---	---	1/2	BMF-F		376 Laundro Pak Seat is Impeller	4761
PS-1002	C	1	1.000	1/2	BCFJF		Convento, Supreme Jet, MTR Jet, Type M 901 thru 906, Type P, all models	1061
PS-200	A	1	1.250	5/8	BMFJF			2661
PS-1000	B	1	1.250	5/8	BMFJF			523-6
PS-151	B	1	1.375	5/8	BMFJF		Types S & SD Lancaster Dutchman-1192,1193,1182,1183	2461
PS-1005A	B	1	1.375	5/8	BMFKF			2561
PS-447	B	9	---	5/8	BCFJF		Model 570, 575, 1775	
PS-493	C	1	1.187	5/8	BCFKF			525-6
PS-201	A	1	1.375	3/4	BMFJF		Type S & SD Lancaster Dutchman 1192,1193,1182,1183	1661
PS-358	C	1	1.375	3/4	BCFJF		Self Priming Pump Model 673	1361
PS-703	D	1	1.500	7/8	BCDJF		Turbo Pak Model 523BF- 524 BG	429 7/8
PS-360	A	1	1.625	1	BMFJF		Type M-907 and M-908	7561
PS-381	D	1	1.875	1-1/4	BCFJF		Type M-909 and M-910	909-61
LEAR SIEGLER (See SHERWOOD BRASS)								
LECOURTENAY								
WHEN SEAL IS MTD. ON A SHAFT, USE THE FOLLOWING								
PS-866	E	3	1.750	1-1/8	BCDJF		Model 3BA2,2-1/2 -BA8	
PS-546	E	3	1.875	1-1/4	BCFJF		Model 3BA7	11481
PS-864	E	3	2.000	1-3/8	BCDJF		Model 4BA7,3BA8,4BA6,6B3	
PS-595	E	3	2.375	1-5/8	BCDJF		Model 5BA6,2-1/2 M7A	11485-8
PS-523	E	1	2.625	1-7/8	BCFJF		Model 4BA8,5BA7	
PS-530	E	3	2.750	2	BCFJF		Model 8BA5	11393
PS-327	E	3	3.000	2-1/8	BCFJF		Model 5MB7	23305, 15168-9
PS-848	E	3	3.125	2-1/4	BCDJF		Model 6BA8,8BA6,10BA4/5	11479-80, 23300, 23304
PS-328	E	3	3.375	2-5/8	BCFJF		Model 6B8,10BA6,10BA7	15165-7, 23301
PS-329	E	3	3.750	2-7/8	BCFJF		Model 8BA8	
WHEN SEAL IS MTD. ON A SLEEVE, USE THE FOLLOWING								
PS-546	E	3	1.875	1-1/4	BCFJF		Model 3-B4	11481
PS-864	E	3	2.000	1-3/8	BCFJF		Model 6B3	
PS-595	E	3	2.375	1-5/8	BCDJF		Model 4-B6	11485-8
PS-530	E	3	2.750	2	BCFJF		Model 5BA6	11393
PS-327	E	3	3.000	2-1/8	BCFJF		Model 6BA5,6BA6	23305, 15168-9
PS-848	E	3	3.125	2-1/4	BCDJF		Model 4BA8,5BA7,8B5	11479-80, 23300, 23304
PS-278	E	3	3.250	2-3/8	BCFJF		Model 8BA5	15170-1
PS-328	E	3	3.375	2-5/8	BCFJF		Model 8BA6,6BA8,10BA4/5	15170-7, 23301
PS-324	E	3	3.875	3	BCDJF		Model 6B8,10BA6,10BA7	11489-93
<i>NOTE: Lecourtenay seals are also available with Ni-Resist seats. (material code K)</i>								
LEHIGH								
PS-752	D	1	1.375	3/4	BCDKF			D-811
PS-108	E	1	1.875	1-1/4	NCPKP			D-845
LELAND FARADAY								
PS-142	B	1	1.000	1/2	BMFJF			
PS-163	B	1	1.000	1/2	BMFJF		Model Number LFP-43000	

WHEN SEAL IDENTIFICATION IS DOUBTFUL, SEND SAMPLE ALONG WITH APPLICATION INFORMATION AND ALL PUMP NAMEPLATE DATA.

PUMP MANUFACTURERS CROSS-REFERENCE

U.S.Seal Part No.	Head	Seat	Seat O.D.	Shaft Dia.	Material Code	Notes	Pump Nameplate Data	MFG. PART #
LELAND FARADAY (continued)								
PS-1000	B	1	1.250	5/8	BMFJF		Model Numbers LFP-2075, 2100, 2150 & 2200	
PS-800	C	1	1.156	5/8	BCFJF		Model Numbers LFP-333 thru 615, 14107 thru 14120, 34105 thru 34320	
PS-877	C	1	1.375	3/4	BCFJF		Model Numbers LFP-533 thru 1100 5050,5075 and 5100	
LEROI INTERNATIONAL								
PS-299	A	---	---	5/8	BMF-F			125-101
PS-687V	C	3	1.500	7/8	VCFKF			125-907
PS-357V	C	3	1.625	1	VCFKF			125-924
PS-598	C	3	1.875	1-1/4	BCFKF			
PS-467	C	1	2.125	1-3/8	BCFKF			
PS-1062	C	3	2.125	1-3/8	VCFGF			
PS-436V	C	3	2.500	1-3/4	VCFKF			125-693-2
LEWIS, CHARLES S. & CO. (Div. of WEIR SPECIALTY PUMPS)								
PS-381	9	1	1.875	1-1/4	BCFJF			
PS-366	10	1	2.500	1-3/4	BCFKF			
LINK BELT								
PS-357	C	1	1.625	1	BCFKF			WB-35
PS-355	C	1	1.750	1-1/8	BCFKF			WB-40
PS-461	D	1	2.375	1-5/8	BCDKF			WB-60
PS-288	D	1	2.500	1-3/4	BCDKF			WB-70
LITTLE GIANT								
PS-163	B	1	1.000	1/2	BMFJF			926024 / 926029 / 926030
PS-165	B	9		1/2	BMFJF	A		108112, 926031
PS-933	C	---	---	5/8	BCF-F			926052
PS-961	B	1	1.250	5/8	BCFJF			926034
PS-552	C	3	1.250	5/8	BCFJF			926053
PS-356V	C	3	1.750	1-1/8	VCFJF			926042 / 926043
LOCKWOOD PUMP								
PS-301	A	1	1.375	3/4	BMFJF			
PS-360	A	1	1.625	1	BCFJF		CM Pump	
LOGANSPOUT								
PS-400	C	---	---	1/2	BMF-F			P-9509
PS-106	C	1	1.000	1/2	BCFKF			P-17251
PS-109	D	---	---	5/8	BCD-F		SF-4, SF-10	P-14883
PS-564	C	---	---	3/4	BCF-F		SF-80, 100, 125, 150	P-9518
LOMART								
PS-150	B	---	---	1/2	BMF-F		Seat is Impeller	
PS-142	B	1	1.000	1/2	BMFJF			
PS-163	B	1	1.000	1/2	BMFJF			40-027, 40-029
PS-1000	B	1	1.250	5/8	BMFJF			
LOUIS PUMP								
PS-370	A	1	1.625	1	BMFKF			
LUITWEILER PUMP								
PS-201	A	1	1.375	3/4	BMFJF			
PS-361	E	1	1.875	1-1/4	BCFJF			
McDONALD A-Y								
PS-166	A	1	1.187	5/8	BMFJF			5MCD1
PS-501	A	1	1.250	5/8	BMFJF		3000, 4000 and 4100 Jet Well	5MCD4
PS-201	A	1	1.375	3/4	BMFJF			5MCD5
PS-521	D	2	1.875	1-1/8	BCDKF			5MCD2

NOTE: A. MOUNTS ON SHAFT

WHEN SEAL IDENTIFICATION IS DOUBTFUL, SEND SAMPLE ALONG WITH APPLICATION INFORMATION AND ALL PUMP NAMEPLATE DATA.



PUMP MANUFACTURERS CROSS-REFERENCE

U.S. Seal Part No.	Head	Seat	Seat O.D.	Shaft Dia.	Material Code	Notes	Pump Nameplate Data	MFG. PART #
MAGNETROL (See SCHAUB ENGINEERING)								
MARINE PRODUCTS (MP PUMP)								
PS-114	A	1	1.000	5/16	BMDJF			
PS-162	A	1	1.000	1/2	BMFJF			21609
PS-165	B	9		1/2	BMFJF	A		
PS-113	B	1	1.093	5/8	BMFJF			13385
PS-447V	B	9		5/8	VCFJF	A	Model 2430	21580
PS-112	C	1	1.375	3/4	BCFKF			15112
PS-358	C	1	1.375	3/4	BCFJF			15151
PS-128V	C	3	1.375	3/4	VCFJF	B	115110, 15150, 15131, 15200, 15241	26640
PS-703	D	1	1.500	7/8	BCDJF			9524
PS-245V -CMS	C	1	1.625	1	VCFJF	B		22272
PS-248V -CMS	C	1	1.625	1	VCFKF	B		22274
PS-248V	C	3	1.625	1	VCFKF			25460
PS-380	D	1	1.625	1	BCFJF			14233
PS-604	D	1	1.750	1-1/8	BCDJF			
PS-347	C	1	2.125	1-1/2	BCFJF	B/H		14424, 14421
PS-347V -CMS	C	1	2.125	1-1/2	VCFJF	H		22361
PS-378V -CMS	C	1	2.125	1-1/2	BCFKF	B		22363
PS-382	D	1	2.125	1-1/2	BCFJF			
PS-446V -CMS	C	1	2.500	1-3/4	VCFJF			26685
MARINE SWIMMING POOL								
PS-201	A	1	1.375	3/4	BMFJF			
MARLOW (Div. of ITT INDUSTRIES)								
PS-151	B	1	1.375	5/8	BMFJF			42513-00
PS-2161	B	1	1.375	5/8	BMFJF		SCT Series, Stainless Steel	46328-00
PS-411	B	11		5/8	BMFJF	A	Model H23EC-A 1-1/2 HP, 2AF Series	25353-00, 26467-00 23736-00, 25353-20
PS-411V	B	11	---	5/8	VCFJF	A		27678-00, 29163-00 29163Z
PS-201	A	1	1.375	3/4	BMFJF		Argonaut®, Mardur®	38592-00
PS-413	C	25	1.625	1	BCFJF			25355-00, 20760
PS-405	A	25	1.625	1	BMFJF			26473-00
PS-978	C	1	1.750	1-1/4	BCFJF	B	L Series	45672-20
PS-979	C	1	1.750	1-1/4	BCFKF	B		
PS-923	C	25	2.250	1-1/4	BCFJF	B		27452-00, 27233-20
PS-416	D	---	---	1-1/4	BCF-F			27452, 27453
PS-416A	D	25	2.250	1-1/4	BCFJF		3B Series	27224-00, 27223-00 27225-00, 3B28EC-C2
PS-929	C	25	2.000	1-3/8	BCFJF			25481
PS-404	D	25	2.000	1-3/8	BCDJF			25356-00, 26477-00 25356-20
PS-818	C	3	2.375	1-5/8	BCFJF			46983-00
PS-7497	C	25	2.500	1-5/8	VCFJF			28146
PS-514	D	1	2.375	1-5/8	BCDJF		L Series	45673-20
PS-446	C	1	2.500	1-3/4	BCFJF			25357-00
PS-550	C	3	2.500	1-3/4	BCFJF		Model 6 EL	47182
PS-267	C	1	2.750	2	BCFJF			25358-00
PS-478	E	1	2.687	2	BCFKF			
MASSEY FERGUSON								
PS-642	B	---	---	5/8	BMF-F			892-563M1
PS-647	B	---	---	3/4	BMF-F			1019-293M1

WHEN SEAL IDENTIFICATION IS DOUBTFUL, SEND SAMPLE ALONG WITH APPLICATION INFORMATION AND ALL PUMP NAMEPLATE DATA.

NOTE: A. MOUNTS ON SHAFT
B. TAPERED SPRING
H. SPRING HOLDER NOT INCLUDED



PUMP MANUFACTURERS CROSS-REFERENCE

U.S.Seal Part No.	Head	Seat	Seat O.D.	Shaft Dia.	Material Code	Notes	Pump Nameplate Data	MFG. PART #
MEGATOR CORP.								
PS-633	C	1	1.250	5/8	BCFKF			5079
PS-112	C	1	1.375	3/4	BCFKF			5479
PS-687	C	1	1.500	7/8	BCFKF			5679
PS-355	C	1	1.750	1-1/8	BCFKF			5879
PS-756	C	1	1.875	1-1/4	BCFKF			5779
PS-659	C	1	2.125	1-1/2	BCFKF			5979
MEMPHIS PUMP								
PS-100	A	1	1.187	5/8	BMFJF			0625-6BC
PS-118	C	1	1.187	5/8	BCFJF			
PS-1091	C	1	1.187	5/8	VCFJF			
PS-508	D	1	1.250	5/8	BCDJF			
PS-201	A	1	1.375	3/4	BMFJF			
PS-1092	C	1	1.375	3/4	VCFKF			
PS-1093	C	1	1.375	3/4	VCFJF			
PS-1094	C	1	1.625	1	VCFJF			
MEPCO: (Marshall Engineered Products Co.) See DUNHAM-BUSH								
METAL MASTER								
PS-150	B	---	---	1/2	BMF-F		Seat is Impeller	12515
PS-680	A	1	1.187	5/8	BCFJF			19023
PS-702	A	1	1.187	5/8	BMFJF		Close Coupled Circulator	15110
PS-153	A	1	1.250	5/8	BMFKF		Swim Pool Pump	
PS-200	A	1	1.250	5/8	BMFJF			
PS-151	B	1	1.375	5/8	BMFJF		Circulator Hi Lift	
MET PRO CORPORATION (DEAN BROTHERS)								
PS-6860	B	2	1.250	5/8	TCFJF			6960444
PS-1000V	B	3	1.250	5/8	VCFJF			6960440
PS-397V	C	3	1.625	1	VCFKF			6765570
PS-236V	E	3	1.625	1	VCFKF			6764554, 6765583
PS-1056V	C	3	2.500	1-3/4	VCFKF			6765941
PS-366V	E	3	2.500	1-3/4	VCFKF			6764540, 6765965
MEYER MAJONNIER								
PS-227	D	1	1.750	1	BCFKF			750062149
MIDCO MFG.								
PS-600	B	1	1.187	5/8	BMFJF			
PS-601	B	1	1.375	3/4	BMFJF			
MIDLAND PRODUCTS (Div. of CRANE PUMPS & SYSTEMS)								
PS-201	A	1	1.375	3/4	BMFJF			6070-0
PS-360	A	1	1.625	1	BCFJF		Models: 5M, 7M and 18M	6007-0
PS-177	C	1	2.000	1-3/8	BCFJF		Models: 40M and 40W	
PS-805	C	3	2.000	1-3/8	BCFJF			6368-0
PS-550	C	3	2.500	1-3/4	BCFJF			6412-0
PS-532	C	3	2.750	2	BCFJF			6428-0
MILRECO								
PS-448	C	1	2.500	1-3/4	BCFKF			RMB-414
MONARCH INDUSTRIES								
PS-200	A	1	1.250	5/8	BMFJF			240160
PS-200V	A	3	1.250	5/8	VCFJF			240136
PS-201	A	1	1.375	3/4	BMFJF			24034/MS17, 240170
PS-201V	A	3	1.375	3/4	VCFJF			24034/MS44
								240344
PS-851	A	1	1.375	3/4	BCFJF			240260
PS-185	C	1	1.875	1-1/4	BCFJF			240070
PS-185V	C	3	1.875	1-1/4	VCFJF			240359
PS-835	D	3	3.375	2-1/2	BCDJF			240363
PS-838	E	3	3.500	2-3/4	BCFJF			240290



PUMP MANUFACTURERS CROSS-REFERENCE

U.S.Seal Part No.	Head	Seat	Seat O.D.	Shaft Dia.	Material Code	Notes	Pump Nameplate Data	MFG. PART #
MONTGOMERY WARD								
PS-358	C	1	1.375	3/4	BCFJF			24181
MORETRENCH								
PS-7766	K	3	3.125	2-1/4	BCFJF			
MURPHY DIESEL								
PS-358	C	1	1.375	3/4	BCFJF			MD-4090
PS-1095	C	---	---	1	BCF-F			MD-7980B1
MUSKIN								
PS-142	B	1	1.000	1/2	BMDJF			09-2013
PS-163	B	1	1.000	1/2	BMDJF			09-2001
MYERS, F.E. (Div. of PENTAIR)								
PS-1621	Q	9	---	1/2	BMFJF	A		21607A
PS-200	A	1	1.250	5/8	BMFJF		10840A1, A2, A3	14525A,16275A
PS-200V -CMS	A	1	1.250	5/8	VCFJF			21181A-044
PS-359	C	1	1.250	5/8	BCFJF			22447A
PS-359V -CMS	C	1	1.250	5/8	VCFJF			21181A-021
PS-508	D	1	1.250	5/8	BCDJF			10840A1
PS-101	A	1	1.437	3/4	BMFJF		Models H, HN, MHN & K	11416A, A2, A3
PS-968	A	1	1.439	3/4	BCFJF			11416A-000
PS-902	B	9	---	3/4	BMFKF			21579A
PS-1125	C	1	1.375	3/4	BCFJF			25370A
PS-7277	C	1	1.437	3/4	BCFJF			21181A-17
PS-7514	C	1	1.437	3/4	BCFJF			
PS-309	C	1	1.500	7/8	BCFJF			21576A
PS-7130	C	1	1.500	7/8	BCFJF			WG-20-21-15
PS-703	D	1	1.500	7/8	BCDJF		Model 125 Centro-Thrift	11716A-11
PS-983V	C	3	1.750	1-1/8	VCFKF			21181A-6
PS-204	E	1	1.750	1-1/8	BCFJF			8824A-1
PS-185	C	1	1.875	1-1/4	BCFJF			22577A
PS-381	D	1	1.875	1-1/4	BCFJF		Model 2695	15218A
PS-758	C	1	2.125	1-1/2	BCFJF			22922A 22922A-000
PS-2209	C	1	2.125	1-1/2	BZFZF			21181A-013
PS-238	C	1	2.375	1-5/8	BCFJF			21181A-32
PS-2212	C	1	2.500	1-3/4	BCFJF			22883-A
PS-237	D	1	2.500	1-3/4	BCDJF		300 FS-VG4D	
NASH_ELMO								
PS-100	A	1	1.187	5/8	BMFJF		HTG Pump	
PS-100V -CMS	A	1	1.187	5/8	VCFJF			PK-389
PS-452	B	9		5/8	BMFJF	A	S1-1/4C	
PS-600	B	1	1.187	5/8	BMFJF			PK-339
PS-600V -CMS	B	1	1.187	5/8	VCFJF			PK-654
PS-764	A	1	1.375	3/4	BCFJF			PK-482, PK-10
PS-944	C	1	1.375	3/4	BCFJF		MH-34, 25, 15	PK-842
PS-204	E	1	1.750	1-1/8	BCFJF		11 Vertical	PK-295
PS-282	U	3	1.750	1-1/8	BCFKF			PK-334
PS-354	E	1	2.000	1-3/8	BCFJF		AL 621	PK-475
PS-177	C	1	2.000	1-3/8	BCFJF		MH-50, MH-80	PK-874
PS-177V	C	3	2.000	1-3/8	VCFJF			PK-2044
PS-864	E	1.687	2.000	1-3/8	BCFJF			PK-873
PS-758	C	1	2.125	1-1/2	BCFJF			PK-791
PS-382	D	1	2.125	1-1/2	BCFJF		MPS-673	PK-624
PS-305	E	1	2.125	1-1/2	BCFJF		MP-40	PK-678
PS-884	K	1	2.125	1-1/2	BCFKF		MPS-40	

WHEN SEAL IDENTIFICATION IS DOUBTFUL, SEND SAMPLE ALONG WITH APPLICATION INFORMATION AND ALL PUMP NAMEPLATE DATA.

NOTE: A. MOUNTS ON SHAFT



PUMP MANUFACTURERS CROSS-REFERENCE

U.S. Seal Part No.	Head	Seat	Seat O.D.	Shaft Dia.	Material Code	Notes	Pump Nameplate Data	MFG. PART #
NASH_ELMO (continued)								
PS-550	C	3	2.500	1-3/4	BCFJF		AT-94	PK-900
PS-340	C	1	2.625	1-7/8	BCFJF			PK-893
PS-874	D	1	3.125	2-1/4	BCDJF		1-1/2 H-6	PK-341
PS-2089	D	3	3.125	2-1/4	BCFJF			PK-479
PS-838	E	3	3.500	2-3/4	BCFJF			PK-523
PS-2116	C	3	3.875	3	BCFJF		AD-303	PK-937
NATIONAL ICE CORP.								
PS-359	C	1	1.250	5/8	BCFJF			
NELSON MFG. CORP.								
PS-236	E	1	1.625	1	BCFKF			60AY-12
PS-371	D	1	2.125	1-1/2	BCFKF			60BC11
PS-1097	D	1	2.625	1-7/8	BCDKF			60BC12
NEPTUNE								
PS-150	B	---	---	1/2	BMF-F		Seat is Impeller	
OBERDORFER								
PS-671	B	1	.875	3/8	BMDJF		IGCC Pump	32373
PS-671V -CMS	B	1	.875	3/8	VCDJF			
PS-1098	B	1	.875	1/2	BMFJF		Model 142	32482
PS-600	B	1	1.187	5/8	BMFJF		4GP, 9GP, RA-TV, RB-TB	
PS-642	B	---	---	5/8	BMF-F		4GP, 9GP, RA-TV, RB-TB	A-6019, A-5377
PS-933V	C	---	---	5/8	VCF-F			9798
PS-359	C	1	1.250	5/8	BCFJF			A-5935
PS-235	C	1	1.625	1	BCFJF			32315
OHLER								
PS-141	R	---	---	1	BCF-F			
PS-235	C	1	1.625	1	BCFJF			
PS-357	C	1	1.625	1	BCFKF			
PS-185	C	1	1.875	1-1/4	BCFJF			
PS-186	D	1	2.000	1-3/8	BCDKF			
PS-209	K	---	---	1-3/8	BCF-F			
OMAN								
PS-165	B	9		1/2	BMFJF	A		131A169
OSBORNE ENGINEERING								
PS-162	A	1	1.000	1/2	BMFJF			
OSMONICS, INC.								
PS-359	C	1	1.250	5/8	BCFJF			1113515
PS-235V	C	3	1.625	1	VCFJF			1115730
PS-618	C	3	1.875	1	BCFJF			1121167
PACER								
PS-601	B	1	1.375	3/4	BCFJF			714-11
PS-601V	B	3	1.375	3/4	VCFJF			714-14
PAC-FAB (See PUREX/HYDROTECH)								
PS-952	A	1	1.250	5/8	BCFJF		AV-7 Pump	23822
PS-100	A	1	1.187	5/8	BMFJF			P28280 7 Series
PS-200	A	1	1.250	5/8	BMFJF		Challenger®, Dynamite Dynamo®, Dynatron®, Pinnacle®	354545
PS-501	A	1	1.250	5/8	BMFJF		Aquatron	P28322, 071733
PS-1000	B	1	1.250	5/8	BMFJF		Whisperflo	P28323, 071734
PS-201	A	1	1.375	3/4	BMFJF		AH Series, L Series, Hydropump®	P28300, 071728, 354001
PS-360	A	1	1.625	1	BCFJF		C Series	P28175, 071725

NOTE: A. MOUNTS ON SHAFT

WHEN SEAL IDENTIFICATION IS DOUBTFUL, SEND SAMPLE ALONG WITH APPLICATION INFORMATION AND ALL PUMP NAMEPLATE DATA.



PUMP MANUFACTURERS CROSS-REFERENCE

U.S.Seal Part No.	Head	Seat	Seat O.D.	Shaft Dia.	Material Code	Notes	Pump Nameplate Data	MFG. PART #
PACIFIC PUMPING CO. (PACO)								
PS-200	A	1	1.250	5/8	BMFJF			SL-7101, SL-7741 K102-1
PS-516	A	1	1.250	5/8	BCFJF			14010242
PS-628	A	3	1.250	5/8	BMFKF			14008630 K100-7, K102-7
PS-1618	C	1	1.250	5/8	BCFJF	B		14032695
PS-2149	C	3	1.250	5/8	BCFKF			14032688
PS-508	D	1	1.250	5/8	BCDJF			SL-7100
PS-201	A	1	1.375	3/4	BMFJF			K101-1
PS-973	A	1	1.375	3/4	BCFKF			K101-7
PS-112V	C	3	1.375	3/4	VCFKF			14032363
PS-768	C	3	1.375	3/4	BCFKF			14032689
PS-750	D	1	1.375	3/4	BCDJF		Model 1-1/2LRV, 1-1/4JS	75BF2C1
PS-752	D	1	1.375	3/4	BCDKF			SL-7104
PS-703	D	1	1.500	7/8	BCDJF			SL-7098
PS-235	C	1	1.625	1	BCFJF			SL-7735
PS-380	D	1	1.625	1	BCFJF			SL-7087
PS-460	D	1	1.625	1	BCFKF			SL-7106
PS-754	E	1	1.625	1	BCFJF			1400-7521
PS-204	E	1	1.750	1-1/8	BCFJF			SL-7770
PS-756	C	1	1.875	1-1/4	BCFKF			SL-7094
PS-756V	C	3	1.875	1-1/4	VCFKF			K107-6
PS-2122	C	1	1.875	1-1/4	BCFJF			14032698, K105-1 K-107-1
PS-1109	C	3	1.875	1-1/4	BCFKF			14032691 K105-7
PS-1109V	C	3	1.875	1-1/4	VCFKF			K105-6 14032365
PS-137	E	1	1.875	1-1/4	BCFKF			SL-8102
PS-361	E	1	1.875	1-1/4	BCFJF		Model 2CLSU-3ALR	14007099
PS-361V -P66	E	3	1.875	1-1/4	VCDJF	I		14007083
PS-137V -P66	E	3	1.875	1-1/4	VCFKF	I		14008732, K600-6
PS-758	C	1	2.125	1-1/2	BCFJF			SL-7107
PS-371	D	1	2.125	1-1/2	BCFKF			SL-7107
PS-305	E	1	2.125	1-1/2	BCFJF			SL-8223
PS-374	E	1	2.125	1-1/2	BCFKF	H		
PS-446	C	1	2.500	1-3/4	BCFJF			K104-1
PS-2142	C	1	2.500	1-3/4	BCFJF			14032700
PS-2150	C	3	2.500	1-3/4	BCFJF			K108-1 / K106-1
PS-2151	C	3	2.500	1-3/4	BCFKF			14032693, K303-7
PS-2151V	C	3	2.500	1-3/4	VCFKF			K108-6 K106-6
PS-205	E	1	2.500	1-3/4	BCFJF		Model 3CLSU	SL-7090, 14007090
PS-262	E	3	2.500	1-3/4	BCFKF		KP3014-516	14008148 K307-71 29-5015-47001 14009965, 14008650
PS-366	E	1	2.500	1-3/4	BCFKF			SL-8398
PS-477	E	3	2.750	2	BCFKF			
PS-479	E	1	2.750	2	BCFJF			K-602-1
PS-530	E	3	2.750	2	BCFJF			K-602-6
PS-843	E	1	2.750	2	BCFKF			K-602-7
PS-323	E	1	3.125	2-1/4	BCDJF			1400-1709/1400-7709
PS-351	E	1	3.125	2-1/4	BCDKF			1401-7123 K308-71 29-60122-47001
PS-1688	E	3	3.125	2-1/4	BCFJF			SEA-21225, K111-1
PS-2094V	E	3	3.125	2-1/4	VCFKF			K-111-6

WHEN SEAL IDENTIFICATION IS DOUBTFUL, SEND SAMPLE ALONG WITH APPLICATION INFORMATION AND ALL PUMP NAMEPLATE DATA.

NOTE: B. TAPERED SPRING
H. SPRING HOLDER NOT INCLUDED
I. ABRASION RESISTANT CARBON (P66)



PUMP MANUFACTURERS CROSS-REFERENCE

U.S.Seal Part No.	Head	Seat	Seat O.D.	Shaft Dia.	Material Code	Notes	Pump Nameplate Data	MFG. PART #
PEABODY-BARNES MFG.								
PS-163	B	1	1.000	1/2	BMFJF			18189
PS-165	B	9		1/2	BMFJF	A		29726
PS-200	A	1	1.250	5/8	BMFJF		For Comet, Rocket Econo, 25,31,33,35,48,49,50,52,102DM and 740DM	11397-12839, 12703
PS-359	C	1	1.250	5/8	BCFJF			18873A
PS-552	C	3	1.250	5/8	BCFJF			23701
PS-508	D	1	1.250	5/8	BCDJF			5080
PS-201	A	1	1.375	3/4	BMFJF		Vertical Single and Multi Stage 152,152DM, 202D, 202DM, 302D 302DM and 502DM	13110, 14017122
PS-358	C	1	1.375	3/4	BCFJF			15344, 67562
PS-235	C	1	1.625	1	BCFJF			18004-30090
PS-236	E	1	1.625	1	BCFKF			8022
PS-879	K	1	1.625	1	BCFJF			64434
PS-185	C	1	1.875	1-1/4	BCFJF		Models: 18ACG, 18, 19, 23 & 26 CCG	19146, 70713
PS-598	C	3	1.875	1-1/4	BCFKF		3TACG Int 1020	33289
PS-383	D	1	1.875	1-1/4	BCFKF			12074
PS-228	K	3	1.875	1-1/4	BCFKF		Model 3TCCG	25328A
PS-1118	K	1	1.875	1-1/4	BC/HFJF			39485
PS-7323	K	1	1.937	1-1/4	BC/ZFJZF			60817
PS-177	C	1	2.000	1-3/8	BCFJF			52601
PS-547	C	3	2.000	1-3/8	BCFKF			39463
PS-553	C	3	2.125	1-1/2	BCFKF			31000
PS-758	C	1	2.125	1-1/2	BCFJF			24998
PS-237	D	1	2.500	1-3/4	BCDJF		371.000	13301
PS-2237	K	1	2.625	1-7/8	BCFJF			051938
PS-332	C	3	2.750	2	BCFKF			53626
PEACOCK ENGR.								
PS-647	B	---	---	3/4	BMF-F			IN-9177
PEERLESS (Div. of STERLING FLUID SYSTEMS)								
PS-162	A	1	1.000	1/2	BMFJF			2665554
PS-100	A	1	1.187	5/8	BMFJF			2665171
PS-200	A	1	1.250	5/8	BMFJF			2658090
PS-300	A	1	1.250	5/8	BMFJF		Convertible & single stage jet Water King	2655294-V12271 1181377-2665624
PS-628	A	3	1.250	5/8	BMFKF			2692269
PS-263	D	1	1.187	5/8	BCDKF			2675336
PS-102	D	1	1.250	5/8	BCDKF			2680496
PS-508	D	1	1.250	5/8	BCDJF			2666910
PS-301	A	1	1.375	3/4	BMFJF		Single Stage Jet: J2G, J3G 1J, 2J, 3J 15J, 75J,1GJ	2655293,RP-118138 26650131
PS-750	D	1	1.375	3/4	BCDJF			2655888, 2663071
PS-265	D	3	1.375	3/4	BCDKF			2675337
PS-303	D	1	1.500	7/8	BCDKF			2655239, 2664873
PS-250	D	3	1.500	7/8	BCDKF			2675339, 2690421-01
PS-188	E	1	1.500	7/8	BCFJF			2663072, 2657110
PS-229	E	3	1.500	7/8	BCFKF			2675338
PS-778	A	3	1.625	1	BMFKF			2692914
PS-380	D	1	1.625	1	BCFJF		PE-200,PE-300, PE-500 Fluidyne	2613940, 2663369
PS-252	D	3	1.625	1	BCFKF			2675341, 2664873 2690421-02
PS-754	E	1	1.625	1	BCFJF			2655887
PS-251	E	3	1.625	1	BCFKF			2675340, 2656324
PS-604	D	1	1.750	1-1/8	BCFJF			2658071
PS-605	D	1	1.750	1-1/8	BCFKF		TVB-58, Turbine Vane Pump	2655131
PS-254	D	3	1.750	1-1/8	BCFKF			2675344, 2655131
PS-204	E	1	1.750	1-1/8	BCFJF			2663077

NOTE: A. MOUNTS ON SHAFT

WHEN SEAL IDENTIFICATION IS DOUBTFUL, SEND SAMPLE ALONG WITH APPLICATION INFORMATION AND ALL PUMP NAMEPLATE DATA.



PUMP MANUFACTURERS CROSS-REFERENCE

U.S.Seal Part No.	Head	Seat	Seat O.D.	Shaft Dia.	Material Code	Notes	Pump Nameplate Data	MFG. PART #
PEERLESS (Div. of STERLING FLUID SYSTEMS) (continued)								
PS-253	E	3	1.750	1-1/8	BCFKF		Model 300-90	2675343, 2664886 2675317
PS-255	E	3	1.875	1-3/16	BCDKF			2675345, 2690421-03
PS-306	E	1	1.875	1-3/16	BCDJF			2655886
PS-1109	C	3	1.875	1-1/4	BCFKF			2687626, 2687165
PS-1109V	C	3	1.875	1-1/4	VCFKF			268716501
PS-1109 -EPR	C	3	1.875	1-1/4	QCFKF			2687926
PS-361	E	1	1.875	1-1/4	BCFJF		PB-3, 3 x 4 x 10	2657093, 2663048
PS-256	E	3	1.875	1-1/4	BCFKF			2675347, 2664893
PS-264	E	3	1.875	1-1/4	BCFKF			2675318, 2687266
PS-547	C	3	2.000	1-3/8	BCFKF			269794702
PS-257	E	3	2.000	1-3/8	BCFKF			2675350
PS-354	E	1	2.000	1-3/8	BCFJF			2655089, 2663075
PS-677	E	1	2.000	1-3/8	BCFKF			2663368, 2675349
PS-1110	C	3	2.125	1-1/2	BCFKF		F2-1044AM,1230AM, 1240AM	2687166
PS-1110V	C	3	2.125	1-1/2	VCFKF			268716607
PS-2221	C	3	2.125	1-1/2	QCFKF			2691073
PS-382	D	1	2.125	1-1/2	BCFJF			2656981, 2675353
PS-258	E	3	2.125	1-1/2	BCFKF			2675351, 2691073
PS-259	E	3	2.125	1-1/2	BCFKF			2675352
PS-305	E	1	2.125	1-1/2	BCFJF			2675108, 2663008
PS-436	C	3	2.500	1-3/4	BCFKF		AD IV-V	2675319, 2693598
PS-825	D	3	2.500	1-3/4	BCDKF		PE-Pumps	2675356
PS-205	E	1	2.500	1-3/4	BCFJF			2663044
PS-262	E	3	2.500	1-3/4	BCFKF			2675354, 2675355
PS-535	E	3	2.500	1-3/4	BCFJF		MTP FRAME	
PS-312	C	3	2.625	1-7/8	BCFKF			269794703
PS-586	E	3	2.625	1-7/8	BCFKF		Type AD Fig. 5130	2676205
PS-332	C	3	2.750	2	BCFKF		Type AD Group IV, 8AE-12	2675320, 2693599
PS-327	E	3	3.000	2-1/8	BCFJF		Model 6A-16	
PS-353	E	2	3.000	2-1/8	BCFKF		Model 6A-16	
PS-1676	C	3	3.125	2-1/4	BCFKF			2692217
PS-492	C	3	3.250	2-3/8	BCFKF			2693666
PS-483	C	3	3.500	2-3/4	BCFKF		10AE-14	2693601
PS-321	E	3	3.500	2-3/4	BCFKF			2693601
PS-475	E	3	3.875	3	BCDKF		6" 6TU16	
PELLERIN-MILNOR								
PS-750	D	1	1.375	3/4	BCDJF			24S020
PENBERTHY INJECTOR								
PS-162	A	1	1.000	1/2	BMFJF			D-1104
PS-165	B	9		1/2	BMFJF	A		
PS-1112	Q	9		1/2	BMFJF	A		14036
PERFECTED PUMP								
PS-118	C	1	1.187	5/8	BCFJF			
PERFECTING (Div. of DUFF NORTON)								
PS-359	C	1	1.250	5/8	BCFJF			732015
PS-356	C	1	1.750	1-1/8	BCFJF			732049
PS-177	C	1	2.000	1-3/8	BCFJF			732057
PERKINS ENGINEERING								
PS-201V -CMS	A	1	1.375	3/4	VCFJF			586
PESCO								
PS-507	A	1	1.250	5/8	BMFKF			
PHILLIPS GASKET (See CATERPILLAR TRACTOR)								

WHEN SEAL IDENTIFICATION IS DOUBTFUL, SEND SAMPLE ALONG WITH APPLICATION INFORMATION AND ALL PUMP NAMEPLATE DATA.

NOTE: A. MOUNTS ON SHAFT



PUMP MANUFACTURERS CROSS-REFERENCE

U.S.Seal Part No.	Head	Seat	Seat O.D.	Shaft Dia.	Material Code	Notes	Pump Nameplate Data	MFG. PART #
PIONEER (See DETROIT HARVESTER HOWELL)								
PIQUA MACHINE (See ENPO-CORNELL)								
POLARIS								
PS-1000	B	1	1.250	5/8	BMFJF		Vac Sweep	P-55
POWER PRODUCTS (See TECUMSEH)								
PRECISION SCIENTIFIC								
PS-1043	C	1	1.000	1/2	BMFJF			342005
PS-732	C	3	1.250	5/8	BCFKF			342003
PS-1113	C	1	1.375	3/4	BCFKF			342027
PS-499	C	3	1.625	1	BCFKF			342012
PREMIER								
PS-201	A	1	1.375	3/4	BMFJF		Series 120T, 225/255, 300, 325/355, 725/756	31-812
PS-1000	B	1	1.250	5/8	BMFJF		Series 455/456, 500, 600	31-813
PRICE PUMP CO.								
PS-1002V	C	3	1.000	1/2	VCFJF		Model-S95M	
PS-516	A	1	1.250	5/8	BCFJF			0118
PS-447	B	9		5/8	BCFJF	A	Model-E100, E100B, PRYCO-50,75,95	0538
PS-447V	B	9		5/8	VCFJF	A		0539
PS-359	C			5/8	BCFJF			0841
PS-359V	C	3	1.250	5/8	VCFJF		Model-"S" Motor Pumps	0553
PS-201	A	1	1.375	3/4	BMFJF		Model-Sp-15	
PS-601	B	1	1.375	3/4	BMFJF		PRYCO-100, 125, 150	
PS-358V-CMS	C	1	1.375	3/4	VCFJF			0549
PS-235V-CMS	C	1	1.625	1	VCFJF			8304-211
PS-758	C	1	2.125	1-1/2	BCFJF		Model-E150,E200	
PS-7409	C	1	2.125	1-1/2	VCFJF	316 SS		0122
PS-446V-CMS				1-3/4				3516
PROSSER PUMP (Div. of CRANE PUMPS & SYSTEMS)								
PS-1002	C	1	1.000	1/2	BCFJF			558312-2, 558312-21
PS-359	C	1	1.250	5/8	BCFJF		5 HP (S.H. 5/8 Hole)	2-31001
PS-687	C	1	1.500	7/8	BCFKF		15 HP Mod # 9-16034-1	231006
PS-756	C	1	1.875	1-1/4	BCFKF		25 and 40 HP Mod # 9-26032-3	
PULSAFEEDER (Div. of IDEX CORP.)								
PS-1065	C	3	.875	3/8	BCFJF			307328
PS-552	C	3	1.250	5/8	BCFJF		Model 2-17 Type 107	307414
PS-933V	C	---	---	5/8	VCF-F			Y0900421-316
PUREX/HYDROTECH (See PAC-FAB)								
PS-952	A	1	1.250	5/8	BCFJF		AV-7 Pump	23822
PS-360	A	1	1.625	1	BCFJF			28175
QUINCY COMPRESSOR								
PS-483	C	3	3.500	2-3/4	BCFKF			20400-1
RAINBOW IRRIGATION PUMPS								
PS-185	C	1	1.875	1-1/4	BCFJF			14821
PS-466	C	1	2.500	1-3/4	BCFJF			13470
RAPID DAYTON (See TAIT)								
RED JACKET (VEEDER ROOT)								
PS-106	C	1	1.000	1/2	BCFKF		Deep and Shallow Well Type A & B Multi Stage Pumps Models 25A, 33A, 50A, 75A, 100A	540
PS-100	A	1	1.187	5/8	BMFJF		SW-DW Jet Pump	C76-98A-C, C76-78A 176-037

NOTE: A. MOUNTS ON SHAFT

WHEN SEAL IDENTIFICATION IS DOUBTFUL, SEND SAMPLE ALONG WITH APPLICATION INFORMATION AND ALL PUMP NAMEPLATE DATA.



PUMP MANUFACTURERS CROSS-REFERENCE

U.S.Seal Part No.	Head	Seat	Seat O.D.	Shaft Dia.	Material Code	Notes	Pump Nameplate Data	MFG. PART #
RED JACKET (VEEDER ROOT) (continued)								
PS-518	A	1	1.187	5/8	BCFKF			076-183
PS-701	A	1	1.187	5/8	BMFKF			C76-134
PS-711	A	3	1.187	5/8	BMFJF			076-182
PS-493	C	1	1.187	5/8	BCFKF		For Centri-Jet "R" and Centri-Jet V 25R, 33R, 50R, 75R, 100, 101,150, 151	500
PS-102	D	1	1.250	5/8	BCDKF		Deep Well & Shallow Well Type H, Models 25H, 33H, 50H, 75H, 100H	530
PS-201	A	1	1.375	3/4	BMFJF			76-129, 76-189
PS-750	D	1	1.375	3/4	BCDJF		All Types HB Centrifugal Jet Pumps	560
PS-902	B	9		3/4	BMFKF	A	Centri Jet X Pumps 33X and 50X "CJ", "CJM", AND "SJ" Pumps	555, C76-99A
PS-370	A	1	1.625	1	BMFKF			76-132
PS-460	D	1	1.625	1	BCFKF			545
REDA PUMP								
PS-508	D	1	1.250	5/8	BCDJF			17197A
PS-188	E	1	1.500	7/8	BCFJF			13131A
PS-703	D	1	1.500	7/8	BCDJF			14011A
PS-380	D	1	1.625	1	BCFJF			13977A
PS-382	D	1	2.125	1-1/2	BCFJF			15114A
RELIANCE ELECTRIC MFG.								
PS-185	C	1	1.875	1-1/4	BCFJF			64262-12A
PS-185 -TC-TC	C	1	1.875	1-1/4	BZFZF			64262-20A
PS-381	D	1	1.875	1-1/4	BCFJF			64262-8A
PS-758	C	1	2.125	1-1/2	BCFJF			64262-12B
PS-2209	C	1	2.125	1-1/2	BZFZF			64262-20B
PS-7409	C	1	2.125	1-1/2	VCFJF	316 SS		64262-13B
PS-7509	C	1	2.125	1-1/2	VCFJF			
PS-2223	C	3	2.125	1-1/2	VCFZF			
PS-382	D	1	2.125	1-1/2	BCDJF	H		64262-8B
PS-2008	K	1	1.875	1-5/8	BCFZF			64262-20A
PS-2207	C	3	2.500	1-3/4	VCFZF			64262-23C
PS-446	C	1	2.500	1-3/4	BCFJF			64262-12C
PS-446V -CMS	C	1	2.500	1-3/4	VCFJF			64262-13C
PS-237	D	1	2.500	1-3/4	BCDJF			64262-8C
PS-2219	C	1	2.750	2	BZFZF			64262-25DD
PS-267	C	1	2.750	2	BCFJF			64262-12D
PS-267V -CMS	C	1	2.750	2	VCFJF			64262-13D
PS-267V -TC-SEAT	C	3	2.750	2	VCFZF			64262-23D
PS-543	C	1	3.000	2-1/8	BCFKF			611725-05B
PS-2154	C	3	3.500	2-3/4	BCFJF			64262-18F
PS-2116	C	3	3.875	3	BCFJF			64262-12G
PS-2153	C	3	3.875	3	BCFJF			64262-18G
							The following non-standard are available for quotation:	64262-8J
								64262-20C
								64262-20D
								64262-20H
								64262-20N
								64262-23A
REXNORD CONSTRUCTION								
PS-102	D	1	1.250	5/8	BCDKF			X203414/2-9366

WHEN SEAL IDENTIFICATION IS DOUBTFUL, SEND SAMPLE ALONG WITH APPLICATION INFORMATION AND ALL PUMP NAMEPLATE DATA.

NOTE: A. MOUNTS ON SHAFT
H. SPRING HOLDER NOT INCLUDED



PUMP MANUFACTURERS CROSS-REFERENCE

U.S.Seal Part No.	Head	Seat	Seat O.D.	Shaft Dia.	Material Code	Notes	Pump Nameplate Data	MFG. PART #
RICE								
PS-200	A	1	1.250	5/8	BMFJF			21-024
PS-201	A	1	1.375	3/4	BMFJF			12-023
PS-750	D	1	1.375	3/4	BCDJF			0330-9-6
ROBBINS & MYERS								
PS-631	C	1	1.000	1/2	BCFJF			
PS-1002	C	1	1.000	1/2	BCFJF			32-04215
PS-1002-EPR	C	1	1.000	1/2	QCFJF			32-06497-000
PS-1002V	C	1	1.000	1/2	VCFJF			32-06037-000
PS-200	A	1	1.250	5/8	BMFJF			POD-3054
PS-359	C	1	1.250	5/8	BCFJF			32-02424
PS-1119	C	1	1.250	5/8	BCFJF		EM & EC Pumps	32-02423
PS-201	A	1	1.375	3/4	BMFJF		EC-11, EC-55, EC-57, 1200, 1210	32-01625
PS-851	A	1	1.375	3/4	BCFJF			48-65C
PS-358	C	1	1.375	3/4	BCFJF			32-03945-000
PS-360	A	1	1.625	1	BCFJF			EC-67
PS-548	C	3	1.625	1	BCFJF			32-01750
PS-380	D	1	1.625	1	BCFJF			
PS-262	E	3	2.500	1-3/4	BCFKF			0892 EPW / 016629
ROMAR FILTER								
PS-200	A	1	1.250	5/8	BMFJF			618-001
ROPER PUMP CO.								
PS-400	C	---	---	1/2	BMF-F			G14-222-403, 263X
PS-1050	C	---	---	1/2	BCF-F			G14-283, G3-29
PS-933	C	---	---	5/8	BCF-F			G14-116
PS-933V	C	---	---	5/8	VCF-F			G14-13
PS-633	C	1	1.250	5/8	BCFKF			G14-225
PS-564	C	---	---	3/4	BCF-F			G14-117
PS-112	C	1	1.375	3/4	BCFKF			G14-226
PS-112V	C	3	1.375	3/4	VCFKF			G14-471
PS-752	D	1	1.375	3/4	BCDKF			G14-261, G14-266
PS-208	C	---	---	7/8	BCF-F			G14-324
PS-617	C	3	1.500	7/8	BCFKF			G14-227
PS-703	D	1	1.500	7/8	BCDJF			G14-78
PS-936	E	---	---	7/8	BCF-F			G14-119
PS-935	E	1	1.500	7/8	BCFKF			G14-78
PS-397	C	---	---	1	BCF-F			G14-320
PS-235	C	1	1.625	1	BCFJF			G14-338X
PS-357V	C	3	1.625	1	VCFKF			G4-182, G4-437, G14-172
PS-397V	C	3	1.625	1	VCFKF			G14-51
PS-499	C	3	1.625	1	BCFKF		1AM-27	G14-338
PS-499-EPR	C	3	1.625	1	QCFKF			G14-312
PS-937	E	---	---	1	BCF-F			G14-250, G14-120
PS-236	E	1	1.625	1	BCFKF			G14-343
PS-2155	C	3	1.750	1-1/16	BCFKF			G4-101, G14-489
PS-127	D	1	1.750	1-1/16	BCDKF			G14-288
PS-348	C	---	---	1-1/8	BCF-F			G14-278, G4-334
PS-355V	C	3	1.750	1-1/8	VCFKF			G4-375, G4-15
PS-529	C	3	1.750	1-1/8	BCFKF			G4-313
PS-154V	C	---	---	1-1/4	VCF-F			G3-10, G3-36
PS-756	C	1	1.875	1-1/4	BCFKF			G14-229
PS-598	C	3	1.875	1-1/4	BCFKF			G14-229
PS-416	D	---	---	1-1/4	BCF-F	H		G14-121, G14-122
PS-467	C	1	2.125	1-3/8	BCFKF			G14-579
PS-172V	C	---	---	1-3/8	VCF-F			G14-510
PS-186	D	1	2.000	1-3/8	BCDKF			G14-248
PS-2156	C	3	2.250	1-7/16	BCFKF			G4-112

NOTE: H. SPRING HOLDER NOT INCLUDED



PUMP MANUFACTURERS CROSS-REFERENCE

U.S.Seal Part No.	Head	Seat	Seat O.D.	Shaft Dia.	Material Code	Notes	Pump Nameplate Data	MFG. PART #
ROPER PUMP CO. (continued)								
PS-939	D	---	---	1-1/2	BCF-F			G14-123, G14-124
PS-371	D	1	2.125	1-1/2	BCFKF			G14-230
PS-1145	C	3	2.750	2	VCFKF			G4-46
PS-543V	E	3	3.000	2-1/8	VCFKF			G4-41
PS-1676V	C	3	3.125	2-1/4	VCFKF			G14-233
PS-942	D	---	---	2-1/4	BCD-F			G14-125
PS-941	D	1	3.125	2-1/4	BCDKF			G14-223
ROY E. ROTH PUMP								
PS-1120	C	1	1.062	1/2	BCFJF		Size 00-100	F8A030VF
PS-118	C	1	1.187	5/8	BCFJF		Size 0 and 10	F8B015VF/086VL
RUTH BERRY								
PS-102	D	1	1.250	5/8	BCDKF			610
PS-201	A	1	1.375	3/4	BMFJF			601, 601A
PS-750	D	1	1.375	3/4	BCDJF			620
RUTHMAN MACHINERY								
PS-164	B	9		1/2	BMFKF	A	Model 55-4520	906
PS-165	B	9		1/2	BMFJF	A		
PS-452	B	9		5/8	BMFJF	A		
PS-633	C	1	1.250	5/8	BCFKF			
PS-902	B	9		3/4	BMFKF	A		
PS-360	A	1	1.625	1	BCFJF			
PS-235	C	1	1.625	1	BCFJF			
SCHAUB ENGINEERING								
PS-493	C	1	1.187	5/8	BCFKF			12-3113-001
PS-1123	C	1	1.625	1	BCFKF			12-3113-002
PS-598	C	3	1.875	1-1/4	BCFKF			12-3113-003
SCOT PUMP (Div. of ARDOX CORP.)								
PS-200	A	1	1.250	5/8	BMFJF			101-000-340
PS-200V -CMS	A	1	1.250	5/8	VCFJF			101-000-110B
PS-516	A	1	1.250	5/8	BCFJF			118-000-110, 101-000-110C 118-000-102
PS-501	A	1	1.250	5/8	BMFJF			118-000-340D
PS-952	A	1	1.250	5/8	BCFJF			118-000-102, 118-000-340
PS-359V -CMS	C	1	1.250	5/8	VCFJF			101-000-103
PS-633V	C	3	1.250	5/8	VCFKF			101-000-120, 101-000-316
PS-633V -P66	C	3	1.250	5/8	VCFKF	I		101-000-225X
PS-732 -EPR	C	3	1.250	5/8	QCFKF			101-000-173
PS-201V -CMS	A	1	1.375	3/4	VCFJF			101-000-115
PS-112V	C	3	1.375	3/4	VCFKF			101-003-171
PS-309	C	1	1.500	7/8	VCFJF			101-000-156
PS-360	A	1	1.625	1	BCFJF			101-000-294 101-000-159
PS-185	C	1	1.875	1-1/4	BCFJF			101-000-104, 101-000-104A 101-000-294
PS-185V -CMS	C	1	1.875	1-1/4	VCFJF			101-000-194A
PS-185V	C	3	1.875	1-1/4	VCFJF			
PS-756V -CMS	C	1	1.875	1-1/4	VCFKF			101-000-124
PS-756 -EPR	C	1	1.875	1-1/4	QCFKF			101-000-124C

WHEN SEAL IDENTIFICATION IS DOUBTFUL, SEND SAMPLE ALONG WITH APPLICATION INFORMATION AND ALL PUMP NAMEPLATE DATA.

NOTE: A. MOUNTS ON SHAFT
I. ABRASION RESISTANT CARBON (P66)



PUMP MANUFACTURERS CROSS-REFERENCE

U.S.Seal Part No.	Head	Seat	Seat O.D.	Shaft Dia.	Material Code	Notes	Pump Nameplate Data	MFG. PART #
SCOT PUMP (Div. of ARDOX CORP.) (continued)								
PS-756V	C	3	1.875	1-1/4	VCFKF			101-000-179/180
PS-228V	K	3	1.875	1-1/4	VCFKF			101-000-164
PS-758	C	1	2.125	1-1/2	BCFJF			101-000-168 118-000-344
PS-758V	C	3	2.125	1-1/2	VCFJF			101-000-175
PS-659V	C	3	2.125	1-1/2	VCFKF			101-000-182
PS-446	C	1	2.500	1-3/4	BCFJF			101-000-196
PS-436V	C	3	2.500	1-3/4	VCFKF			101-000-221
SCOTSMAN ICE MACHINE								
PS-380	D	1	1.625	1	BCFJF			2-383
SERVICE FILTRATION								
PS-1002	C	1	1.000	1/2	BCFJF			55-434
PS-358	C	1	1.375	3/4	BCFJF			55-407
PS-309	C	1	1.500	7/8	BCFJF			55-488
PS-758V -CMS	C	1	2.125	1-1/2	VCFJF			55-481
SETHCO MFG. CO.								
PS-1002V	C	1	1.000	1/2	VCFJF			
PS-359	C	1	1.250	5/8	BCFJF			
SHERWOOD BRASS								
PS-631	C	1	1.000	1/2	BCFJF			5789
PS-1002	C	1	1.000	1/2	BCFJF			10522
PS-200	A	1	1.250	5/8	BMFJF			10159
PS-452	B	9		5/8	BMFJF	A		8388
PS-447	B	9		5/8	BCFJF	A		12859
PS-508	D	1	1.250	5/8	BCDJF			10523
PS-578	D	---	---	7/8	BCD-F			8570
PS-703	D	1	1.500	7/8	BCDJF			8578
PS-188	E	1	1.500	7/8	BCFJF			9791
SHETLER PUMP								
PS-200	A	1	1.250	5/8	BMFJF			
PS-201	A	1	1.375	3/4	BMFJF			
SHIPPENSBURG (SHIPCO)								
PS-356 -EPR	C	1	1.750	1-1/8	QCFJF			SDPS-00155
SIGMUND PUMP								
PS-356	C	1	1.750	1-1/8	BCFJF			
PS-355V	C	3	1.750	1-1/8	VCFKF			
PS-758	C	1	2.125	1-1/2	BCFJF			
PS-659V	C	3	2.125	1-1/2	VCFKF			
PS-267	C	1	2.750	2	BCFJF			
SIHI								
PS-544	C	3	2.375	1-5/8	BCFKF			501 483
PS-543	C	3	3.000	2-1/8	BCFKF			501 908
SIMMONS								
PS-200	A	1	1.250	5/8	BMFJF		Model 6	
SKIDMORE								
PS-663	Q	1	1.000	1/2	BMFJF			50648
PS-100	A	1	1.187	5/8	BMFJF			142-54049
PS-536	C	3	1.187	5/8	BCFJF			53497
PS-290	C	1	1.250	5/8	BCFJF			142-54099
PS-359	C	1	1.250	5/8	BCFJF			50625-1
PS-508	D	1	1.250	5/8	BCDJF		Condensate Pump	P-15, P-15A 142-54052
PS-309	C	1	1.500	7/8	BCFJF			50625-2, 142-54055
PS-356	C	1	1.750	1-1/8	BCFJF			50625-3, 142-54058



PUMP MANUFACTURERS CROSS-REFERENCE

U.S.Seal Part No.	Head	Seat	Seat O.D.	Shaft Dia.	Material Code	Notes	Pump Nameplate Data	MFG. PART #
SMITH, A.O.								
PS-162	A	1	1.000	1/2	BMFJF			64135, 55831
PS-506	A	1	1.000	1/2	BMFKF			9708-4, 9708-1
PS-752	D	1	1.375	3/4	BCDKF			
SMITH-LOVELESS								
PS-1104	V	25	2.140	1-3/8	BCFJF		Frame 25	
PS-1105	V	25	2.640	1-7/8	BMFJF		Frame 28	
PS-1102	V	25	3.140	2-1/8	BCFJF		Frame 32	
PS-1107	V	25	3.187	2-1/8	BCFJF			
SOMAT CORP.								
PS-359	C	1	1.250	5/8	BCFJF			54300
PS-309	C	1	1.500	7/8	BCFJF			54302
PS-774	C	3	1.500	7/8	BCFJF			
PS-529	C	3	1.750	1-1/8	BCFKF			54311
PS-801	C	3	1.750	1-1/8	BCFJF			54310
PS-544	C	3	2.375	1-5/8	BCFKF			54325
PS-332	C	3	2.750	2	BCFKF			54326
SPP PUMP								
PS-359	C	1	1.250	5/8	BCFJF			
PS-633	C	1	1.250	5/8	BCFKF			
PS-355	C	1	1.750	1-1/8	BCFKF			
PS-356	C	1	1.750	1-1/8	BCFJF			
PS-659	C	1	2.125	1-1/2	BCFKF			
PS-758	C	1	2.125	1-1/2	BCFJF			
PS-267	C	1	2.750	2	BCFJF			
PS-842	C	1	2.750	2	BCFKF			
STA-RITE INDUSTRIES								
PS-1615	B	1	1.000	3/8	BMFJF		Model 297A	U109-173
PS-162	A	1	1.000	1/2	BMFJF			U109-103
PS-142	B	1	1.000	1/2	BMFJF			
PS-163	B	1	1.000	1/2	BMFJF		LT Series	U109-68 SS U109-321 SS
PS-663	Q	1	1.000	1/2	BMFJF			U109-100
PS-100	A	1	1.187	5/8	BMFJF		AJ Series, Dura-Glas Pre 1998, Max-E-Glass pre 1998, PLBC Series Pre 1995	U109-6, U109-6A, U9-48 U109-93SS
							PLBC Series	17351-0102S
PS-200	A	1	1.250	5/8	BMFJF		Dura-Glas, Max-E-Glas	17304-0100S
PS-501	A	1	1.250	5/8	BMFJF			118-000-340
PS-1000	B	1	1.250	5/8	BMFJF		CF/CFA Series, HP Series,	U109-136SS
PS-118	C	1	1.187	5/8	BCFJF			U109-87, U9-102, U109-118
PS-493	C	1	1.187	5/8	BCFKF			U9-1
PS-1618	C	1	1.250	5/8	BCFJF			118-000-340A
PS-201	A	1	1.375	3/4	BMFJF		DJ/JS/JT Series Pre 01/01, Dura-Glas II, Dura-Jet, Dyna-Glas/Dyna-Max, JW/JWPA Series, Max-E-Glas II	U109-358SS, U9-122
							Dura-Glas II pre 1998, Max-E-Glas II pre 1998	U109-372SS
							Dyna-Jet	17351-0101S
PS-201V-CMS	A	1	1.375	3/4	VCFJF			37400-0028S
PS-851	A	1	1.375	3/4	BCFJF		DJ/JS/JT Series, Dura Glass II after 6/00 Dura-Jet after 1/01 Dyna-Glass/Dyna Max after 6/00 JW/JWPA Series after 1/01 Max-E-Glass after 6/00	37400-0027S
PS-1622	B	9		3/4	BCFJF	A		U109-394SS
PS-128	C	1	1.375	3/4	BCFJF	B		U9-99
PS-358	C	1	1.375	3/4	BCFJF			U109-99
PS-877	C	1	1.375	3/4	BCFJF			U109-267
PS-750	D	1	1.375	3/4	BCDJF			U9-43

WHEN SEAL IDENTIFICATION IS DOUBTFUL, SEND SAMPLE ALONG WITH APPLICATION INFORMATION AND ALL PUMP NAMEPLATE DATA.

NOTE: A. MOUNTS ON SHAFT
B. TAPERED SPRING



PUMP MANUFACTURERS CROSS-REFERENCE

U.S. Seal Part No.	Head	Seat	Seat O.D.	Shaft Dia.	Material Code	Notes	Pump Nameplate Data	MFG. PART #
STA-RITE INDUSTRIES (continued)								
PS-687	C	1	1.500	7/8	BCFKF			U9-18,20,22 25,29,32 U109-21, U109-30
PS-774	C	3	1.500	7/8	BCFJF			U109-170
PS-235	C	1	1.625	1	BCFJF			16504
PS-380	D	1	1.625	1	BCFJF		Model-AS-H-3	U9-39, U109-47
PS-127	D	1	1.750	1-1/16	BCDKF			U109-31
PS-866	E	3	1.750	1-1/8	BCFJF			U109-96SS
PS-204	E	1	1.750	1-1/8	BCFJF			U109-96
PS-867 -EPR	E	3	1.750	1-1/8	QCFKF	E		U9-307
PS-185	C	1	1.875	1-1/4	BCFJF		CC/C Series, D Series	U109-433SS
							CC/C Series, D Series pre 8/00	U109-200
							CSPH/CCSPH Series	S-32014
PS-381	D	1	1.875	1 1/4	BCFJF		CC/C Series, D Series	U109-220
PS-804	D	3	1.875	1-1/4	VCFJF		CC/C Series, D Series	U109-220
PS-758	C	1	2.125	1-1/2	BCFJF			16554
PS-446	C	1	2.500	1-3/4	BCFJF		CCPH/CCSPH Series	S-32015
PS-2142	C	1	2.500	1-3/4	BCFJF			S-32692
PS-535	E	3	2.500	1-3/4	BCFJF			U109-251
PS-340	C	1	2.625	1-7/8	BCFJF			S-32694
PS-327	E	3	3.000	2-1/8	BCFJF			U109-252
STEIN SAM ASSOC.								
PS-397	C	---	---	1	BCF-F			401-50-0001
PS-2105	C	---	---	1-1/2	BCF-F			401-50-0006
STERLING FLUID SYSTEMS								
PS-1057	C	3	3.000	2-1/8	B/VCFKF			501908
PS-483	C	3	3.500	2-3/4	BCFKF			502365
STERLING MACHINERY								
PS-201	A	1	1.375	3/4	BMFJF			
PS-564	C	---	---	3/4	BCF-F			
PS-358	C	1	1.375	3/4	BCFJF			1616
PS-145	K	---	---	3/4	BCF-F			
PS-175	K	1	1.375/1.500	3/4	BCFJF			
PS-303	D	1	1.500	7/8	BCDKF			J81-E
PS-1681	D	3	1.437	7/8	BCDKF			
PS-185	C	1	1.875	1-1/4	BCFJF			1636
PS-177	C	1	2.000	1-3/8	BCFJF			1706
PS-178	R	1	2.000	1-3/8	BCDJF			
PS-209	K	---	---	1-3/8	BCF-F			
PS-629	E	3	2.312	1-1/2	BCFKF			133861
PS-216	K	---	---	1-1/2	BCF-F			
PS-213	R	---	---	1-3/4	BCD-F			
PS-217	R	1	2.500	1-3/4	BCDKF			
PS-853	C	3	3.375	2-1/2	BCFKF	E		13498
PS-1058	C	3	3.375	2-1/2	BCFKF	F		20125-H
STERLING PUMP								
PS-524 -EPR	A	1	1.250	5/8	QCFKF			081-004
PS-2166	C	1	1.437	7/8	BCFJF			
PS-2166 -EPR	C	1	1.437	7/8	QCFJF			081-00034
PS-2167	C	1	1.437	7/8	BCFJF			081-00032
PS-2168	C	3	1.437	7/8	BCFKF			
PS-2169	C	3	1.437	7/8	BCFKF			
PS-2169V	C	3	1.437	7/8	VCFKF			081-00027
PS-2224	C	3	1.437	7/8	QCFKF	I		081-00024
PS-790	D	1	1.437	7/8	BCDJF		Style 1KF	623-00006
PS-1681	D	3	1.437	7/8	BCDKF			
PS-758	C	1	2.125	1-1/2	BCFJF			081-00017



PUMP MANUFACTURERS CROSS-REFERENCE

U.S. Seal Part No.	Head	Seat	Seat O.D.	Shaft Dia.	Material Code	Notes	Pump Nameplate Data	MFG. PART #
STERO CO.								
PS-3440	C	1	1.750	1	BCFJF			P57-1697
STEVENS PUMP CO.								
PS-200	A	1	1.250	5/8	BMFJF			16-062-03
STONE BENNETT								
PS-499	C	3	1.625	1	BCFKF			30016
STONE CONST.								
PS-851	A	1	1.375	3/4	BCFJF			32223, 322231H
PS-360	A	1	1.625	1	BCFJF			32224, 322241H
PS-185	C	1	1.875	1-1/4	BCFJF			37692
PS-758	C	1	2.125	1-1/2	BCFJF			37691, 376911H
PS-446	C	1	2.500	1-3/4	BCFJF			377281H
SULLIVAN PALATEK								
PS-1053	C	3	1.875	1-1/4	B/VCFKF	F		519056-08
PS-534	D	3	2.125	1-1/2	BCFKF	H	RP-250, RP-365	A-222599
PS-210V	C	3	2.000	1-3/8	VCFKF			
PS-1055	C	---	---	1-3/4	BCF-F		RPV-125	
PS-1056V	C	3	2.500	1-3/4	VCFKF			519056-6
PS-1057	C	3	3.000	2-1/8	B/VCFKF	F		519056-13
PS-853	E	3	3.375	2-1/2	BCFKF	E	Model 600	
SWABY MFG. CO.								
PS-359	C	1	1.250	5/8	BCFJF			
PS-758	C	1	2.125	1-1/2	BCFJF	H		
PS-446	C	1	2.500	1-3/4	BCFJF			
PS-2120	C	1	3.375	2-1/2	BCFJF			
SWIMQUIP								
PS-201	A	1	1.375	3/4	BMFJF		XL VI/XL VII Series	AS-201
SYNCHROFLO								
PS-360	A	1	1.625	1	BCFJF			13-650-0610
PS-361	E	1	1.875	1-1/4	BCFJF		Model 6 HZ	1-349-001
TACO								
PS-163	B	1	1.000	1/2	BMFJF			106-031
PS-106	C	1	1.000	1/2	BCFKF			131-031
PS-1002	C	1	1.000	1/2	BCFJF		Series 1616	121-008
PS-200	A	1	1.250	5/8	BMFJF			172-009, 172-017
PS-200V	A	3	1.250	5/8	VCFJF			172-006
PS-359	C	1	1.250	5/8	BCFJF			121-009, 122-009
PS-633	C	1	1.250	5/8	BCFKF		Series 1600-9, 131-9, 132-9 133-9, 138-9	170-102RP 1600-170RP
PS-752	D	1	1.375	3/4	BCDKF			142-043
PS-360	A	1	1.625	1	BMDJF			170-021, 170-095
PS-754	E	1	1.625	1	BCFJF			900-012
PS-355	C	1	1.750	1-1/8	BCFKF			950-664RP
PS-356	C	1	1.750	1-1/8	BCFJF			950-670RP
								951-3161-DRP
PS-355V	C	3	1.750	1-1/8	VCFKF			950-667RP
PS-529 -EPR	C	3	1.750	1-1/8	QCFKF			950-664-BRP
PS-204	E	1	1.750	1-1/8	BCFJF			900-024
PS-384	E	1	1.750	1-1/8	BCFKF			840-128
PS-867	E	3	1.750	1-1/8	BCDKF			840-128 BRP
PS-264	E	3	1.875	1-1/4	BCFKF			840-011
PS-305	E	1	2.125	1-1/2	BCFJF			862-029
PS-374	E	1	2.125	1-1/2	BCFKF			862-172
PS-659V	C	3	2.125	1-1/2	VCFKF			950-668RP
PS-758	C	1	2.125	1-1/2	BCFJF			950-671RP
PS-758 -EPR	C	1	2.125	1-1/2	QCFJF			951-3162-BRP 950-665RP

WHEN SEAL IDENTIFICATION IS DOUBTFUL, SEND SAMPLE ALONG WITH APPLICATION INFORMATION AND ALL PUMP NAMEPLATE DATA.

NOTE: E. LOCK COLLAR SOLD SEPARATELY
 F. SEAT IS SLOTTED
 H. SPRING HOLDER NOT INCLUDED



PUMP MANUFACTURERS CROSS-REFERENCE

U.S. Seal Part No.	Head	Seat	Seat O.D.	Shaft Dia.	Material Code	Notes	Pump Nameplate Data	MFG. PART #
TACO								
PS-544	C	3	2.375	1-5/8	BCFKF			950-673RP
PS-267	C	1	2.750	2	BCFJF			950-672RP
PS-842	C	1	2.750	2	BCFKF			950-666RP
PS-1145	C	3	2.750	2	VCFKF			950-669RP
PS-479	E	1	2.750	2	BCFJF		Model 6012	
PS-1676	C	3	3.125	2-1/4	BCFKF			950-674RP
TAIT								
PS-162	A	1	1.000	1/2	BMFJF			W6476
PS-201	A	1	1.375	3/4	BMFJF			25062
PS-921	A	1	1.375	3/4	BMFKF			24820
PS-1125	C	1	1.375	3/4	BCFJF			16519
PS-703	D	1	1.500	7/8	BCDJF			24584
PS-360	A	1	1.625	1	BMFJF			
PS-380	D	1	1.625	1	BCFJF			24963
PS-598	C	3	1.875	1-1/4	BCFKF			W-16524
PS-805	C	3	2.000	1-3/8	BCFJF			16538
PS-267	C	1	2.750	2	BCFJF			
TECUMSEH								
PS-350	E	3	3.250	2-3/8	BCFKF			K-509-9
TEEL PUMP								
PS-631	C	1	1.000	1/2	BCFJF			5P-380
PS-1002	C	1	1.000	1/2	BCFJF		1P610, 1P609	1R-305,5P418
PS-100	A	1	1.187	5/8	BMFJF		2P141, 2P894-2P899, 3P683-684-685 3P-686-687-690-692-715-716	1R311, 5P404, 5P-403
PS-200	A	1	1.250	5/8	BMFJF			1R312, 5P406, 5P-405
PS-200V	A	3	1.250	5/8	VCFJF		1P862, 2P486 optional for 1P746-851 1P854-856-860-884-896-897-952-955 1P996-998-2P004-006-290 3P551-553 3P577	1R300, 5P408
PS-501	A	1	1.250	5/8	BMFJF			1R315, 5P410, 5P-409
PS-516	A	1	1.500	5/8	BCFJF		1P746-851-860-896-897-952-955-996 1P998, 2P004-006-390, 3P551-3P553 3P577, 2P091, 2P092	1R303, 5P407
PS-447	B	9		5/8	BCFJF	A	1P787-793-796-798-831-837, 2P498-503-852, 3P736	1R306, 1P831, 5P402
PS-447V	B	9		5/8	VCFJF	A	Optional for 1P787-793-796-798-831 -1P837, 2P498-503	1R324, 5P365
PS-113	B	1	1.093	5/8	BMFJF		1P795	1R302, 5P366
PS-600	B	1	1.187	5/8	BMFJF			5P-367
PS-1000	B	1	1.250	5/8	BMFJF		2P356-2P360, 2P363-2P366	1R317, 5P368 1R318, 5P369
PS-1152	B	1	1.250	5/8	BMFKF			IR-318
PS-800	C	1	1.156	5/8	BCFJF		1P-849-850-879, 3P547-550- 571-599-648 1P979-984, 2P019-280, PC-18-2PC56	1R307, 5P387, 5P-421
PS-359	C	1	1.250	5/8	BCFJF		1P898, 3P569A, 3P570A	1R304, 1P557, 5P386
PS-359V	C	3	1.250	5/8	VCFJF		1P804, 1P555, 3P569, 3P570	1R310, 5P385
PS-2160	C	1	1.250	5/8	BCFJF		3P511, 3P579, 3P512, 1P861	1R298, 5P420
PS-508	D	1	1.250	5/8	BCDJF			1R316, 5P384, 5P-382
PS-851	A	1	1.375	3/4	BCFJF		1P855-868-869-895, 2P007-008 3P525 3P526, 3P600, 1P913, 1P950, 2P333	1R299, 5P414
PS-201	A	1	1.375	3/4	BMFJF			1R313, 5P412, 5P-411
PS-201V	A	3	1.375	3/4	VCFJF		1P946; Optional for 1P855-868-869 1P895-913-950-979-984, 2P007-008, 3P525-526-600	1R245, 5P413
PS-101	A	1	1.437	3/4	BMFJF			1R319, 5P416
PS-877	C	1	1.375	3/4	BCFJF		Optional for 1P700-702-799-803-947 1P949, 2P391, 2P392, 2P393, 2P394	1R308, 5P389
PS-877V	C	1	1.375	3/4	VCFJF		1P700-702-799-803-947-949, 2P391 2P392, 2P393, 2P394	1R309, 5P388

NOTE: A. MOUNTS ON SHAFT

WHEN SEAL IDENTIFICATION IS DOUBTFUL, SEND SAMPLE ALONG WITH APPLICATION INFORMATION AND ALL PUMP NAMEPLATE DATA.



PUMP MANUFACTURERS CROSS-REFERENCE

U.S. Seal Part No.	Head	Seat	Seat O.D.	Shaft Dia.	Material Code	Notes	Pump Nameplate Data	MFG. PART #
TEEL PUMP (continued)								
PS-750	D	1	1.375	3/4	BCDJF			5P-383
PS-360	A	1	1.625	1	BCFJF			5P-417
PS-235	C	1	1.625	1	BCFJF			5P-390
PS-380	D	1	1.625	1	BCFJF			5P-423
PS-754	E	1	1.625	1	BCFJF			5P-370
PS-355	C	1	1.750	1-1/8	BCFKF			5P-392
PS-356	C	1	1.750	1-1/8	BCFJF		3P582-601-604-609, 2P015, 3P653-656-663, 3P664, 2P141, 3P703-704-705-706, 3P707, 3P737	1R301, 5P391, 3P-608
PS-529	C	3	1.750	1-1/8	BCFKF			5P-393
PS-204	E	1	1.750	1-1/8	BCFJF			5P-373
PS-253	E	3	1.750	1-1/8	BCFKF			5P-372
PS-185	C	1	1.875	1-1/4	BCFJF		2P142, 3P660, 3P661, 3P662	1R439, 5P394
PS-246	C	1	1.875	1-1/4	BCFJF			5P-395
PS-756	C	1	1.875	1-1/4	BCFKF			5P-396
PS-361	E	1	1.875	1-1/4	BCFJF			5P-374
PS-177	C	1	2.000	1-3/8	BCFJF			5P-397
PS-705	E	3	2.062	1-7/16	BCFJF			5P-375
PS-758	C	1	2.125	1-1/2	BCFJF			SP-398
PS-484	E	1	2.312	1-5/8	BCDKF			5P-376
PS-609	E	1	2.312	1-5/8	BCDJF			5P-377
PS-448	C	1	2.500	1-3/4	BCFKF			5P-399
PS-205	E	1	2.500	1-3/4	BCFJF			5P-378
PS-322	K	3	3.500	2-3/4	BCFKF			5P-401
TERRA PRODUCTS								
PS-601V	B	3	1.375	3/4	VCFJF			127135
PS-245V	C	3	1.625	1	VCFJF	B		17035
THELCO CORP.								
PS-348	C	---	---	1-1/8	BCF-F			SU 1774
PS-348V	C	---	---	1-1/8	VCF-F			SU 1778
PS-172	C	---	---	1-3/8	BCF-F			SU 1775
PS-172V	C	---	---	1-3/8	VCF-F			SU 1789
PS-2108	C	---	---	1-3/4	BCF-F			SU 1776
PS-2108V	C	---	---	1-3/4	VCF-F			SU 1780
THERMO KING								
PS-159	D	3	1.625	1	NCPGP			220203, 220378
PS-1128	D	3	1.875	1-1/4	NCPKF	H		1210A02G01
THRUSH								
PS-163	B	1	1.000	1/2	BMFJF			
PS-106	C	1	1.000	1/2	BCFKF		GT, GTB, GTN Series Circulators 1/3, 1/2, 3/4 HP	
PS-600	B	1	1.187	5/8	BMFJF			AA-190, AA-199
PS-290	C	1	1.250	5/8	BCFJF		1-1/2TV3/4, 2TV3/4, J #s 1, 2, 3, 4	
PS-633V -CMS	C	1	1.250	5/8	VCFKF			TX-022/024
PS-208	C	---	---	7/8	BCF-F			9765-0260
PS-687	C	1	1.500	7/8	BCFKF		1-1/2TV1, 2TV1, 3TV1, 1-1/2ATV1, 2VTB1, 2TV1-1/2, 2TVB1-1/2, 2TV2, 3TV1-1/2, 3TV2, N# 's 1, 2, 3, 4	
PS-687V	C	3	1.500	7/8	VCFKF			TX-026/028
PS-348	C	---	---	1-1/8	BCF-F			9765-0300
PS-355	C	1	1.750	1-1/8	BCFKF		2TV3, 2-1/2TV3, 3TV3, 5TV3, 5ATV3, 2-1/2TV5, 3TV5, 5TV5, 5ATV5, Series R #s 1, 2, 3, 4	
PS-154	C	---	---	1-1/4	BCF-F			9765-0520
PS-598 -EPR	C	3	1.875	1-1/4	QCFKF			7307-000-1

WHEN SEAL IDENTIFICATION IS DOUBTFUL, SEND SAMPLE ALONG WITH APPLICATION INFORMATION AND ALL PUMP NAMEPLATE DATA.

NOTE: B. TAPERED SPRING
H. SPRING HOLDER NOT INCLUDED



PUMP MANUFACTURERS CROSS-REFERENCE

U.S.Seal Part No.	Head	Seat	Seat O.D.	Shaft Dia.	Material Code	Notes	Pump Nameplate Data	MFG. PART #
THRUSH (continued)								
PS-756V	C	3	1.875	1-1/4	VCFKF			TX052/054
PS-172	C	---	---	1-3/8	BCF-F			9765-0340
PS-210	C	1	2.000	1-3/8	BCFKF		2-1/2TV7-1/2, 3TV7-1/2, 3TV1, 5ATV7-1/2, 2-1/2TV10, 4TV10 5TV15, Series V #'s 3, 4	
PS-210V	C	3	2.000	1-3/8	VCFKF			TX-035/036
PS-2107	C	---	---	1-5/8	BCF-F			9765-0560
PS-239V	C	3	2.375	1-5/8	VCFKF			TX-056/058
TOLEDO								
PS-501	A	1	1.250	5/8	BMFJF			A14067
TONKAFLOW								
PS-548	C	3	1.625	1	BCFJF			
TORO COMPANY								
PS-200V -CMS	A	1	1.250	5/8	VCFJF			42088
TRANE								
PS-192	C	3	2.125	1-1/2	NCFGP			X10063400000
TRIPLEX HEATING								
PS-165	B	9		1/2	BMDJF	A		
PS-452	B	9		5/8	BMFJF	A		
PS-202	B	11		5/8	BMFJF	A		
TRUPAR								
PS-507	A	1	1.250	5/8	BMFKF			P-1190
PS-102	D	1	1.250	5/8	BCDKF			P-11048
PS-201	A	1	1.375	3/4	BMFJF			P-11201
TRW (See REDA PUMP)								
TUTHILL PUMP CO.								
PS-633	C	1	1.250	5/8	BCFKF			2C1B9
PS-768	C	3	1.375	3/4	BCFKF			3C1B9
PS-499	C	3	1.625	1	BCFKF			5C1B9
TUTHILL VACUUM SYSTEMS								
PS-768	C	3	1.375	3/4	BCFKF			062238 / 065238
PS-355V	C	3	1.750	1-1/8	VCFKF			065049-A000
PS-154V	C	---	---	1-1/4	VCF-F			065220-0000
UNIFLOW								
PS-200	A	1	1.250	5/8	BMFJF			
UNITED SERVICE EQUIPMENT								
PS-1133	C	1	1.181	7/16	NCFJF			1034A7
U.S. ELECTRICAL MOTOR								
PS-358	C	1	1.375	3/4	BCFJF			PUL-2112
PS-356	C	1	1.750	1-1/8	BCFJF			
PS-320	C	1	2.250	1-1/2	BCFJF		Frame 213	
U.S. FILTER								
PS-1687	D	1	3.000	2.125	BCFKF			U18080
VERTIFLOW								
PS-358	C	1	1.375	3/4	BCFJF			SJ-2112-C1-00
PS-238	C	1	2.375	1-5/8	BCFJF			SJ-2126-C1-00
PS-185V -CMS	C	1	1.875	1-1/4	VCFJF			SJ-2120-C1-X0
PS-7409	C	1	2.125	1-1/2	VCFJF	316 SS		SJ-2124-C1-X2

NOTE: A. MOUNTS ON SHAFT

WHEN SEAL IDENTIFICATION IS DOUBTFUL, SEND SAMPLE ALONG WITH APPLICATION INFORMATION AND ALL PUMP NAMEPLATE DATA.



PUMP MANUFACTURERS CROSS-REFERENCE

U.S.Seal Part No.	Head	Seat	Seat O.D.	Shaft Dia.	Material Code	Notes	Pump Nameplate Data	MFG. PART #
VIC CLEANING MACHINE								
PS-162	A	1	1.000	1/2	BMDJF			22-907
PS-701	A	1	1.187	5/8	BMFKF			42-607
VIKING INSTRUMENT								
PS-162	A	1	1.000	1/2	BMFJF			1-3438-3
VIKING PUMP (Div. of IDEX CORP.)								
PS-164	B	9		1/2	BMFKF	A	F-566	
PS-632	C	1	1.000	1/2	BCFKF			
PS-633	C	1	1.250	5/8	BCFKF			
PS-1625	C	3	1.250	5/8	BCFKF			2-472-014-999-00
PS-1626	C	3	1.250	5/8	VCFKF			2-472-015-999-00
PS-112	C	1	1.375	3/4	BCFKF		H865	
PS-460	D	1	1.625	1	BCFKF			2-475-002-999-00
PS-159	D	3	1.625	1	NCPGP		HS-195	2-475-005-999-00
PS-1630	D	3	1.625	1	BCPKF		HL-195	2-475-001-999-00
PS-1630V	D	3	1.625	1	VCPKF			2-475-012-999-00
PS-1166	E	3	1.625	1.000	BCFKF			2-475-115-999
PS-1631	T	3	1.625	1	NCPKF		HL-124	2-475-004-999-00
PS-383	D	1	1.875	1-1/4	BCFKF			2-477-015-999-00
PS-1632	D	3	1.875	1-1/4	NCPKF	H	AS, AK & AL 195	2-477-100-999-00
PS-7105	C	3	2.250	1-7/16	BCFKF			2-477-288-999-00
PS-1634	E	3	2.250	1-7/16	BCPKP		L & LL 4151 H, HJ, HL75G	2-477-008-999-00 2-477-027-999-00
PS-943	E	3	2.312	1-7/16	NCPGP		L-190, KK-190, KK-200U or G	2-477-001-999-00
PS-943V	E	3	2.312	1-7/16	VCPGP			2-477-038-999-00
PS-819	D	3	2.375	1-5/8	BCDKF		LS-4124	2-478-011-999-00
VILTER MFG. CORP.								
PS-193	D	3	2.750	2	NCPGP		Model 320	A-33620-A
PS-889	R	3	3.375	2-1/2	NCPGP		430VMC 4-1/2 x 3-1/2	
VULCAN HART DISHWASHER								
PS-1618	C	1	1.250	5/8	BCFJF	B		106410
PS-508	D	1	1.250	5/8	BCDJF			106410
PS-360	A	1	1.625	1	BCFJF			97505
PS-236	E	1	1.625	1	BCFKF			97049
PS-1167	C	1	1.750	1-1/8	BCFKF	B		97522
PS-604	D	1	1.750	1-1/8	BCFJF			97522
WDM PUMPS								
PS-864V	D	3	2.000	1-3/8	VCDKF			MSIXFCEA138
PS-436V	C	3	2.500	1-3/4	VCFKF			MS21XFNRAC134
WABCO (See LEROI INTERNATIONAL)								
WATEROUS CO.								
PS-360	A	1	1.625	1	BCFJF			V-1888
PS-499	C	3	1.625	1	BCFKF			
PS-605	D	1	1.750	1-1/8	BCFKF			V-1467
PS-598	C	3	1.875	1-1/4	BCFKF			V-2145
PS-383	D	1	1.875	1-1/4	BCFKF			V-1150
PS-659V	C	3	2.125	1-1/2	VCFKF			
PS-374	E	1	2.125	1-1/2	BCFKF			V-2662
WATTS								
PS-680	A	1	1.187	5/8	BCFJF		Close Coupled Circulator	
PS-1000	B	1	1.250	5/8	BMFJF			
WAUKESHA MOTORS								
PS-642	B	---	---	5/8	BMF-F			102320 & 20B
PS-1522	A	---	---	3/4	BMF-F			810350
PS-201	A	1	1.375	3/4	BMFJF			152243-B
PS-647	B	---	---	3/4	BMF-F			120828

WHEN SEAL IDENTIFICATION IS DOUBTFUL, SEND SAMPLE ALONG WITH APPLICATION INFORMATION AND ALL PUMP NAMEPLATE DATA.

NOTE: A. MOUNTS ON SHAFT
B. TAPERED SPRING
H. SPRING HOLDER NOT INCLUDED



PUMP MANUFACTURERS CROSS-REFERENCE

U.S. Seal Part No.	Head	Seat	Seat O.D.	Shaft Dia.	Material Code	Notes	Pump Nameplate Data	MFG. PART #
WAUKESHA MOTORS (continued)								
PS-752	D	1	1.375	3/4	BCDKF			
PS-685	R	1	1.500	7/8	BCDKF			108025
PS-1619	B	1	1.625	1	BMDJP			117177G-J
PS-380	D	1	1.625	1	BCFJF			
PS-604	D	1	1.750	1-1/8	BCFJF			157475, 157475K 157475E
PS-185	C	1	1.875	1-1/4	BCFJF			178033
WAYNE HOME EQUIPMENT								
PS-162	A	1	1.000	1/2	BMFJF			15717/56106
PS-163	B	1	1.000	1/2	BMFJF			15863/56108
PS-1137	B	1	1.000	1/2	BMFJF			15780/56107
PS-400	C	---	---	1/2	BMF-F			15189
PS-200	A	1	1.250	5/8	BMFJF		Series SJ-CJX	15559/56104
PS-642	B	---	---	5/8	BMF-F			
PS-1000	B	1	1.250	5/8	BMFJF			15996/56109
PS-1155	C	1	1.187	5/8	BCFJF		Series J and S	15529
PS-201	A	1	1.375	3/4	BMFJF			15693/56105
PS-201V	A	3	1.375	3/4	VCFJF			16229
WAYNE WATER SYSTEMS								
PS-150	B	---	---	1/2	BMF-F			16722
WEBER INDUSTRIES								
PS-359V -CMS	C	1	1.250	5/8	VCFJF			70X120-M
PS-358V -CMS	C	1	1.375	3/4	VCFJF			70X121-M
PS-356V -CMS	C	1	1.750	1-1/8	VCFJF			70X118-M
PS-185V -CMS	C	1	1.875	1-1/4	VCFJF			70X123-M
PS-446V -CMS	C	1	2.500	1-3/4	VCFJF			70X125-M
WEBSTER ELECTRIC								
PS-218	A	---	---	5/8	BCF-F			
PS-467	C	1	2.125	1-3/8	BCFKF			151-26815
WEIL PUMP COMPANY								
PS-100	A	1	1.187	5/8	BMFJF		1-1/4" Submersible	17-30009-005
PS-600	B	1	1.187	5/8	BMFJF			SA-894
PS-989	C	1	1.187	5/8	NCDJF	B		SA-743
PS-1000	B	1	1.250	5/8	BMFJF			
PS-851	A	1	1.375	3/4	BCFJF			17-62372-008
PS-358	C	1	1.375	3/4	BCFJF			205-016-101
PS-358V -CMS	C	1	1.375	3/4	VCFJF			205-093-101
PS-750	D	1	1.375	3/4	BCDJF			X1397, X2372
PS-617	C	3	1.500	7/8	BCFKF			X3452
PS-380	D	1	1.625	1	BCDJF	H		X992
PS-2033	D	3	1.625	1	BCDJF			17-62427-000
PS-754	E	1	1.625	1	BCFJF			X993
PS-356	C	1	1.750	1-1/8	BCFJF			137-000-129
PS-604	D	1	1.750	1-1/8	BCFJF			X2428
PS-802	D	3	1.750	1-1/8	BCFJF			17-62428-008
PS-204	E	1	1.750	1-1/8	BCDJF			
PS-384	E	1	1.750	1-1/8	BCFKF			PNX217UKY
PS-866	E	3	1.750	1-1/8	BCFJF	E		17-61117-008
PS-381	D	1	1.875	1-1/4	BCFJF			X2174, X-2429UKY
PS-804	D	3	1.875	1-1/4	VCFJF			17-62429-006
PS-1623	K	3	2.125	1-1/4	BCFJ/KF			17-05511-001

NOTE:
 B. TAPERED SPRING
 E. LOCK COLLAR SOLD SEPARATELY
 H. SPRING HOLDER NOT INCLUDED

WHEN SEAL IDENTIFICATION IS DOUBTFUL, SEND SAMPLE ALONG WITH APPLICATION INFORMATION AND ALL PUMP NAMEPLATE DATA.



PUMP MANUFACTURERS CROSS-REFERENCE

U.S.Seal Part No.	Head	Seat	Seat O.D.	Shaft Dia.	Material Code	Notes	Pump Nameplate Data	MFG. PART #
WEIL PUMP COMPANY (continued)								
PS-210	C	1	2.000	1-3/8	BCFKF		Model AS	
PS-758	C	1	2.125	1-1/2	BCFJF			205-228-001
PS-926	C	3	2.312	1-1/2	BCFJF			SA-772
PS-514	D	1	2.375	1-5/8	BCDJF		Model AYM-2-1/2x3	
PS-1142	K	3	2.500	1-3/4	BCFJ/KF			17-05514-005
PS-523	E	1	2.625	1-7/8	BCFJF		Model AYM-4x5	
PS-847	D	3	3.125	2-1/4	BCDKF		AYM 5 & 6	17-62550-009
WEINMAN (Div. of CRANE PUMPS & SYSTEMS)								
PS-501	A	1	1.250	5/8	BMFJF		Types-4, 5, 6 & 8 ACK, 4&6AEK	Q26-77
PS-309	C	1	1.500	7/8	BCFJF			Q26-394-Y02
PS-188	E	1	1.500	7/8	BCFJF		Type 2SB	Q26-177-Y03
PS-245	C	1	1.625	1	BCFJF	B	Types- 6AC, 8AC, 4AE, & 6AE	Q26-201-Y02
PS-248	C	1	1.625	1	BCFKF	B	Types- 6AC, 8AC, 4AE, & 6AE	Q26-143-Y34
PS-380	D	1	1.625	1	BCFJF			Q26-78-Y03
PS-204	E	1	1.750	1-1/8	BCFJF			Q26-184-Y03
PS-384	E	1	1.750	1-1/8	BCDKF			Q26-102-Y35
PS-228	K	3	1.875	1-1/4	BCFKF		FR#11, 3UE-B11, 4UD-B11, 4UE-B11	Q26-190-Y34
PS-185	C	1	1.875	1-1/4	BCFJF			Q26-395-Y02
								Q26-166-Y02
PS-246	C	1	1.875	1-1/4	BCFJF	B	Group A-Type 1G, 1-1/4G, 1-1/2G, 1-1/2K, 1-1/2KH, 2G, GB, and KB. Grp. B-7-1/2 HP & Less at 1750: 20 HP & less at 3500 RPM Types. 1-1/2KH,2K, 2-1/2G, 2-1/2K, 3G, 3K, 4GL, and 4G	Q26-166-Y02
PS-249	C	1	1.875	1-1/4	BCFKF	B		Q26-276-Y34
PS-1082	C	1	1.875	1-1/4	NCFKF			Q26-395-Y24
PS-2122	C	1	1.875	1-1/4	BCFJF			Q26-243-Y02
PS-2123	C	1	1.875	1-1/4	BCFKF			Q26-102-Y34
PS-185	C	1	1.875	1-1/4	BCFJF	I		Q26-395-Y21
-P66								
PS-756	C	1	1.875	1-1/4	BCFKF			Q26-395-Y34
PS-756V	C	3	1.875	1-1/4	VCFKF			Q26-395-Y06
PS-381	D	1	1.875	1-1/4	BCDJF	H		Q26-79-Y03
PS-383	D	1	1.875	1-1/4	BCFKF			Q26-5-Y35
PS-137	E	1	1.875	1-1/4	BCFKF			Q26-102-Y35
PS-361	E	1	1.875	1-1/4	BCFJF		When Seal is Mounted on Shaft: 2L-4, 5, 6, 3L-6, 4L3, 5L3	Q26-243-Y03
PS-264	E	3	1.875	1-1/4	BCFKF			Q26-243-Y35
PS-264	E	3	1.875	1-1/4	BCFKF			Q26-243-Y34
PS-7702	E Balanced	3	1.875	1-3/8	BCFJF			
PS-347	C	1	2.125	1-1/2	BCFJF	B/H	Group B-10 HP , Over at 1750; 25 HP Over at 3500 RPM 1-1/2KH, 2K, 2-1/2G, 2-1/2K, 3G 3K, 4GL, 4G. Group C TYP.- 2-1/2KH.	Q26-167-Y02
PS-378	C	1	2.125	1-1/2	BCFKF	B/H		Q26-175-Y34
PS-382	D	1	2.125	1-1/2	BCFJF			Q26-167-Y03
PS-305	E	1	2.125	1-1/2	BCFJF		When Seal is Mounted on Sleeve: 2L-4, 2L-5, 3L-6, 4L-2, 4L-3, 5L-3. When Seal is Mounted on Shaft: 2-1/2JC, 3L-4, 3L-5, 4L-1, 5L-2, 6L-2, 6L03.	Q26-264-Y03
PS-374	E	1	2.125	1-1/2	BCFKF			Q26-265-Y35
PS-258	E	3	2.125	1-1/2	BCFKF			Q26-178-Y35
PS-395	E	3	2.125	1-1/2	BCFJF			Q26-178-Y03
								Q26-178-Y02
PS-239V	C	3	2.375	1-5/8	VCFKF			Q26-373-Y06
PS-544	C	3	2.375	1-5/8	BCFKF			Q26-373-Y34
PS-818	C	3	2.375	1-5/8	BCFJF			Q26-373-Y02
PS-744	E	1	2.375	1-5/8	BCDKF			Q26-241-Y35

WHEN SEAL IDENTIFICATION IS DOUBTFUL, SEND SAMPLE ALONG WITH APPLICATION INFORMATION AND ALL PUMP NAMEPLATE DATA.

NOTE:
 B. TAPERED SPRING
 H. SPRING HOLDER NOT INCLUDED
 I. ABRASION RESISTANT CARBON (P66)



PUMP MANUFACTURERS CROSS-REFERENCE

U.S. Seal Part No.	Head	Seat	Seat O.D.	Shaft Dia.	Material Code	Notes	Pump Nameplate Data	MFG. PART #
WEINMAN (Div. of CRANE PUMPS & SYSTEMS) (continued)								
PS-745	E	1	2.375	1-5/8	BCDJF		When Seal is Mounted on Shaft: Type 3JC, 4L-4, 5L-1, 8L-3	Q26-240-Y03
PS-822	E	3	2.375	1-5/8	BCDKF			Q26-240-Y35
PS-1699	E	3	2.375	1-5/8	BCFKF			Q26-240-Y34
PS-205	E	1	2.500	1-3/4	BCFJF		When Seal is Mounted on Sleeve: Type 3L-4, 3L-5, 4L-1, 5L-2, 6L-2, 6L-3. When Seal is Mounted on Shaft: 2-1/2JC.	Q26-222-Y03 Q26-217-Y03
PS-262	E	3	2.500	1-3/4	BCFKF			Q26-217-Y35 Q26-217-Y34
PS-366	E	1	2.500	1-3/4	BCFKF			Q26-223-Y35
PS-535	E	2.375	2.000	1-3/4	BCFJF			Q26-217-Y25
PS-2231	E Balanced	3	2.375	1-3/4	BCFKF			Q26-304-Y34
PS-7821	E Balanced	3	2.375	1-3/4	BCFZF			Q26-319-Y10
PS-449	K	1	2.500	1-3/4	BCFJF		Frame #12-3UE, 4UD, 4UE-B12 Frame #13: 4UF, 5UF, 6UG-B13	Q26-191-Y02
PS-2170	U	3	2.500	1-3/4	BCFJF			Q26-179-Y03
PS-479	E	1	2.750	2	BCFJF		When Seal is Mounted on Shaft: Type 6L-1, 8L-2, 10L-2, 10L-3. When Seal Mounted on Sleeve: 4L-4, 5L-1 and 8L-3.	Q26-267-Y03
PS-477	E	3	2.750	2	BCFKF			Q26-268-Y35
PS-7892	E Balanced	3	2.625	2	BCFKF			Q26-305-Y34
PS-385A	U	3	2.750	2	BCFKF		3JC and 5LI Split Case	Q26-180-Y35
PS-385ASS	U	3	2.750	2	BCFKF			Q26-180-Y34
PS-278	E	3	3.250	2-3/8	BCFJF		When Seal is Mounted on Shaft: 8L-1, 12L-2. When Seal is Mounted on Sleeve: 6L-1, 8L-2, 10L-3.	Q26-273-Y03
PS-350	E	3	3.250	2-3/8	BCFKF			Q26-274-Y35 Q26-181-Y35 Q26-181-Y34
PS-279	E	3	3.375	2-1/2	BCFJF		Pump Type 10L-2, Seal is Mounted on Sleeve.	Q26-182-Y03
PS-349	E	3	3.375	2-1/2	BCFKF			Q26-198-Y35
PS-7927	E Balanced	3	3.375	2-5/8	BCFKF			Q26-340-Y34
PS-2158	K	1	3.375	2-1/2	BCFJF			Q26-406-Y02
PS-324	E	3	3.875	3	BCDJF		Type 8L-1, 12L-2 Seal is Mtd. on Sleeve	Q26-199-Y03
PS-475	E	3	3.875	3	BCDKF			Q26-183-Y35
WEIR SPECIALTY PUMPS								
PS-758	C	1	2.125	1-1/2	BCFJF			157258
PS-7409	C	1	2.125	1-1/2	VCFJF	316 SS		157256
PS-1679	C	1	3.125	2-1/4	BCFJF			52600
PS-2120	C	1	3.375	2-1/2	BCFJF			157599
WELLS BLOOMFIELD								
PS-359	C	1	1.250	5/8	BCFJF			35902
WEMCO (Division of WEIR SPECIALTY PUMPS)								
PS-541	K	1	1.125	1-1/2	BCFJF			157174
WESTINGHOUSE								
PS-663	Q	1	1.000	1/2	BMFJF			69782
WHEELER, C.H.								
PS-218	A	---	---	5/8	BCF-F			
PS-702	A	1	1.187	5/8	BMFJF		Reuse Brass Seat Housing	
WHITE								
PS-701	A	1	1.187	5/8	BMFKF			
PS-200	A	1	1.250	5/8	BMFJF			



PUMP MANUFACTURERS CROSS-REFERENCE

U.S. Seal Part No.	Head	Seat	Seat O.D.	Shaft Dia.	Material Code	Notes	Pump Nameplate Data	MFG. PART #
WORTHINGTON (Div. of FLOWERVE CORP.)								
PS-928	C	---	---	9/16	BCF-F		1 GA	55954
PS-200	A	1	1.250	5/8	BMFJF		Model 1-1/40CS-5, 1-1/4OM-5	43008
PS-200V	A	3	1.250	5/8	VCFJF			55016
PS-507	A	1	1.250	5/8	BMFKF		1-1/2PM3	
PS-359	C	1	1.250	5/8	BCFJF			50675
PS-359V	C	1	1.250	5/8	VCFJF			05501600, 74315409
-CMS								
PS-528	A	1	1.375	5/8	BMFJF		Delta 512 and 520	PO-2098
PS-626	C	1	1.375	5/8	VCFJF		Delta 520	PO-2099
PS-933	C	---	---	5/8	BCF-F		2GAR, 2GA	55955
PS-951	C	3	1.375	5/8	VCFKF		Delta 512 and 520	PO-2752
PS-201	A	1	1.375	3/4	BMFJF		1-1/2PE, 3 & 4	
PS-373	C	1	1.375	3/4	BCFKF		Frame 1A, DN2	26493, 26492
PS-157	C	---	---	3/4	BCF-F		3 & 4GAR, GAM, GR, 4GAMIS	
PS-564	C	---	---	3/4	BCF-F		2GAM, 4GAM	24439
PS-768	C	3	1.375	3/4	BCFKF			SEL 244
PS-578	D	---	---	7/8	BCD-F		5 & 6 AUM	
PS-936	E	---	---	7/8	BCF-F		5 & 6 GAUM	24440
PS-560SS	U	2	1.562	15/16	BCFKF		Frame 1	26456, 31446
PS-370	A	1	1.625	1	BMFKF			
PS-348	C	---	---	1-1/8	BCF-F			PO-2885
PS-355V	C	3	1.750	1-1/8	VCFKF		Frame 1 D-812, 820, 1012, 1020	PO-2889 w/ PO-2893
PS-529	C	3	1.750	1-1/8	BCFKF		Frame 1 D-812, 820, 1012, 1020	PO-2885 w/ PO-2893
PS-356V	C	3	1.750	1-1/8	VCFJF		Frame 1 D-812, 820, 1012, 1020	PO-2889 w/ PO-2897
PS-801	C	3	1.750	1-1/8	BCFJF		Frame 1 D-812, 820, 1012, 1020	PO-2885 w/ PO-2897
PS-866	E	3	1.750	1-1/8	BCFJF	E	Frame 1 D-1011, 1021	PO-2869 w/ PO-2897
PS-867	E	3	1.750	1-1/8	BCFKF	E	Frame 1 D-1011, 1021	PO-2869 w/ PO-2893
PS-282	U	3	1.750	1-1/8	BCFKF		2-1/2 LR10	51610, 53129
PS-394	U	3	1.875	1-1/4	BCF/DKF		2, 2-1/2 GRM1, 3GRWMC1	31448, 74295924
PS-177V	C	3	2.000	1-3/8	VCFJF		Frame 2 D-812, 820, 1012, 1020	PO-2890 w/ PO-2898
PS-210V	C	3	2.000	1-3/8	VCFKF		Frame 2 D-812, 820, 1012, 1020	PO-2890 w/ PO-2894
PS-547	C	3	2.000	1-3/8	BCFKF		Frame 2 D-812, 820, 1012, 1020	PO-2886 w/ PO-2894
PS-805	C	3	2.000	1-3/8	BCFJF		Frame 2 D-812, 820, 1012, 1020	PO-2886 w/ PO-2898
PS-864	E	3	2.000	1-3/8	BCFJF		Frame 2 D-811, 821, 1011, 1021	PO-2870 w/ PO-2898
PS-865	E	3	2.000	1-3/8	BCFKF		Frame 2 D-811, 821, 1011, 1021	PO-2870 w/ PO-2894
PS-561SS	U	1	2.000	1-3/8	BCFKF		Frame 2 2-1/2 LR-13	50498, 26457
PS-258	E	3	2.125	1-1/2	BCFKF		3LR-9, 4,5,& 6LR-10, 3LR-12, 4LR-12, 1-1/2LLR-7, 1-1/2LLR-10, 2LLR-9	51612 w/ 53130
PS-395	E	3	2.125	1-1/2	BCFJF		3LR-9, 4,5 & 6LR-10, 3LR-12, 4LR-12 1-1/2LLR-7, 1-1/2LLR-10, 2LLR-9	51708 w/ 53130
PS-458	U	3	2.375	1-5/8	BCDKF		4LR-14, 5LR-13, 4LR-11	51613 w/ 53132
PS-436	C	3	2.500	1-3/4	BCFKF		Frame 3 D-812, 820, 1012, 1020	PO-2887 w/ PO-2895
PS-550	C	3	2.500	1-3/4	BCFJF		Frame 3 D-812, 820, 1012, 1020	PO-2887 w/ PO-2899
PS-535	E	2.375	2.500	1-3/4	BCFJF		Frame 3 D-811, 821, 1011, 1021	PO-2871 w/ PO-2899
PS-262	E	2.375	2.000	1-3/4	BCFKF		Frame 3 D-811, 821, 1011, 1021	PO-2871 w/ PO-2895
PS-555	U	1	2.500	1-3/4	BCFKF		Frame 3	26458
PS-555SS	U	1	2.500	1-3/4	BCFKF		Frame 3	50499
PS-513	E	1	2.625	1-7/8	BCFKF		4GRWM	31449
PS-1108	V	1	2.625	1-7/8	BMFJF		4FNC-10	
PS-582	C	3	3.000	2	BCPGP			
PS-477	E	3	2.750	2	BCFKF		2" HBL, 4GRM, 5GRWM	31450
PS-456	U	3	2.750	2	BCFKF		5LR-15, 6LR-13, 6LR-16, 8LR-13	51614 w/ 53133
PS-854	C	3	2.875	2-1/8	BCFJF		Frame 4 D-1012, 1020	PO-2888 w/ PO-2900
PS-855	C	3	2.875	2-1/8	BCFKF		Frame 4 D-1012, 1020	PO-2888 w/ PO-2896
PS-856	E	3	2.875	2-1/8	BCFJF	E	Frame 4 D-1011, 1021	PO-2872 w/ PO-2900
PS-857	E	3	2.875	2-1/8	BCFKF	E	Frame 4 D-1011, 1021	PO-2872 w/ PO-2896
PS-556	U	2	3.000	2-1/8	BCFKF		Frame 4	26459, 50500
PS-475	E	3	3.875	3	BCDKF		6LR-18, 10LR-15	55426 w/ 55425
PS-330	E	3	4.125	3-1/4	BCDJF	E	6 UZD-1	

WHEN SEAL IDENTIFICATION IS DOUBTFUL, SEND SAMPLE ALONG WITH APPLICATION INFORMATION AND ALL PUMP NAMEPLATE DATA.

NOTE: E. LOCK COLLAR SOLD SEPARATELY



PUMP MANUFACTURERS CROSS-REFERENCE

U.S.Seal Part No.	Head	Seat	Seat O.D.	Shaft Dia.	Material Code	Notes	Pump Nameplate Data	MFG. PART #
YOEMAN (See CLOW CORP.)								
ZOELLER COMPANY								
PS-1149	Q	9		1/2	BMFJF	A	Model #34, 36, 54 & 56	34-035
PS-397	C	---	---	1	BCF-F			7767
PS-356	C	1	1.750	1-1/8	BCFJF			6510
PS-185	C	1	1.875	1-1/4	BCFJF			8165
PS-2209	C	1	2.125	1-1/2	BZFZF			7011
PS-758	C	1	2.125	1-1/2	BCFJF			6500
PS-340	C	1	2.625	1-7/8	BCFJF			7131

NOTE: A. MOUNTS ON SHAFT

WHEN SEAL IDENTIFICATION IS DOUBTFUL, SEND SAMPLE ALONG WITH APPLICATION INFORMATION AND ALL PUMP NAMEPLATE DATA.